

LIGHT



—
—
—

--	--	--	--

LIGHT

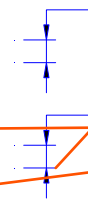
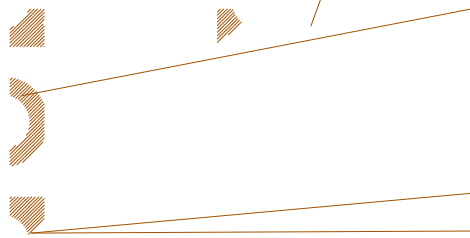

--	--	--	--

LIGHT



Condition for is IFP pulse: Pulse Width 0.1ms and duty 1/10.

--	--	--	--

保潔

LIGHT

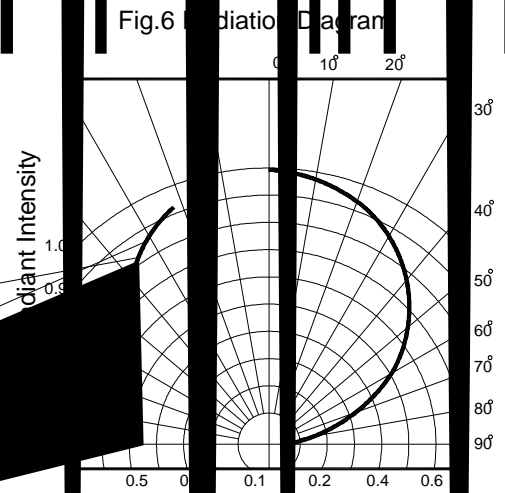
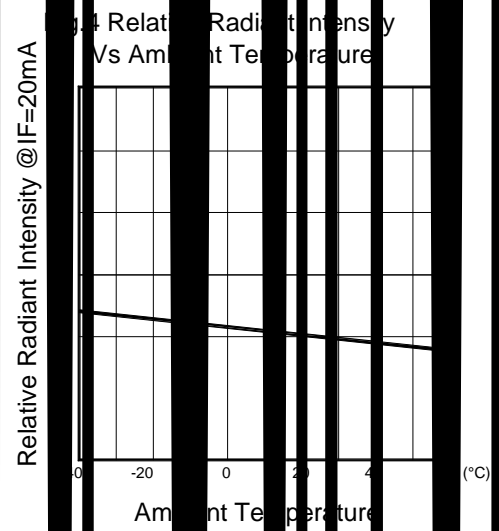
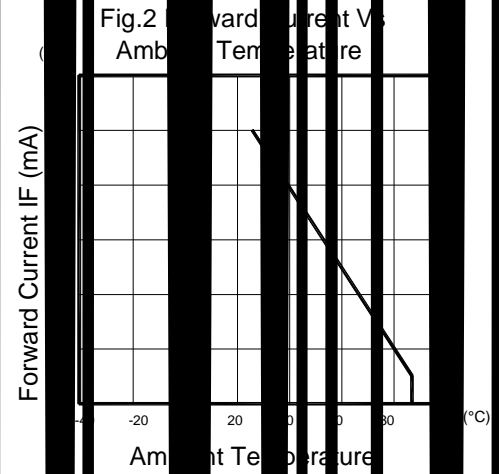
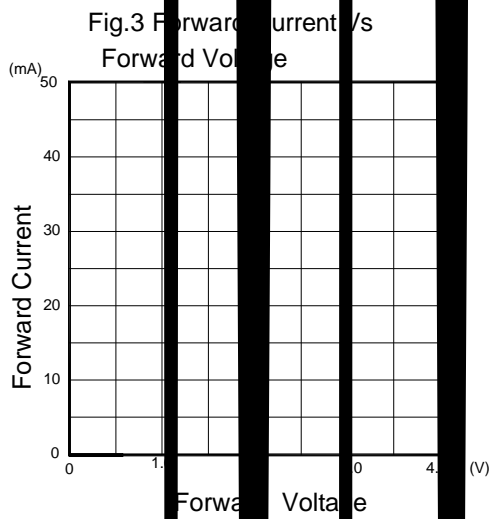

LIGHT

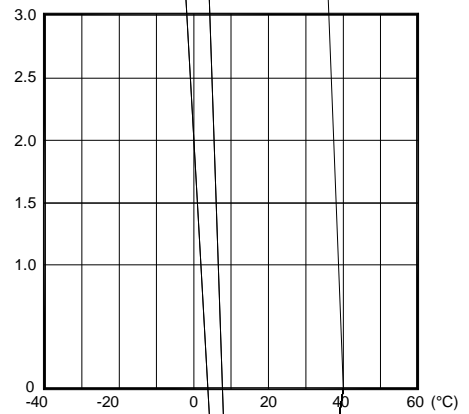
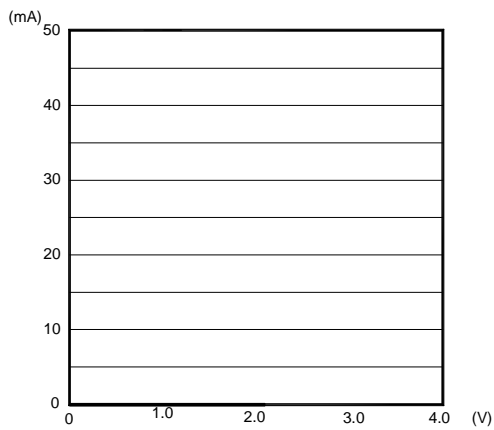

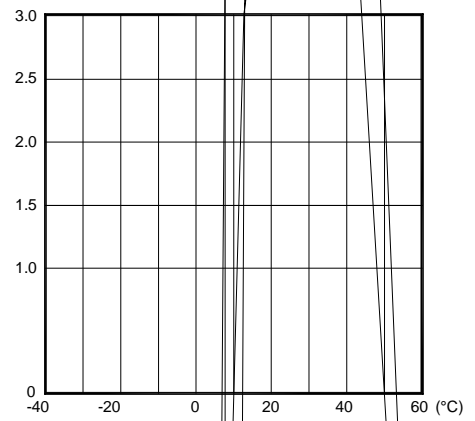
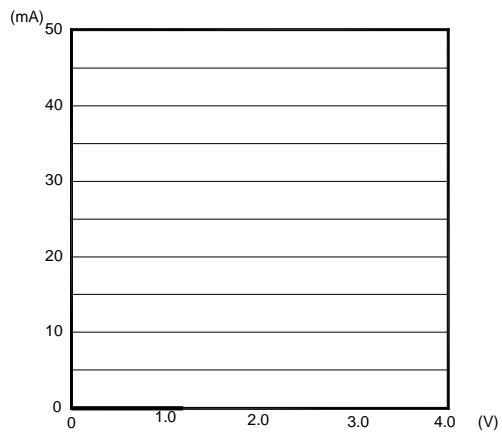

0.5 0.3 0.1 0.2 0.4 0.6

LIGHT



0.5 0.3 0.1 0.2 0.4 0.6

Label Explanation

LIGHT	
Light Electronics CO., LTD.	
MODEL NAME: _____	 LOT NO. : _____
QUANTITY: _____	
BIN: _____	
PACKING DATE: _____	
REMARKS: _____	

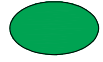

Reel Dimensions

--	--	--	--

LIGHT



Carrier Tape Specifications (Loaded Quantity: 5000pcs/reel)

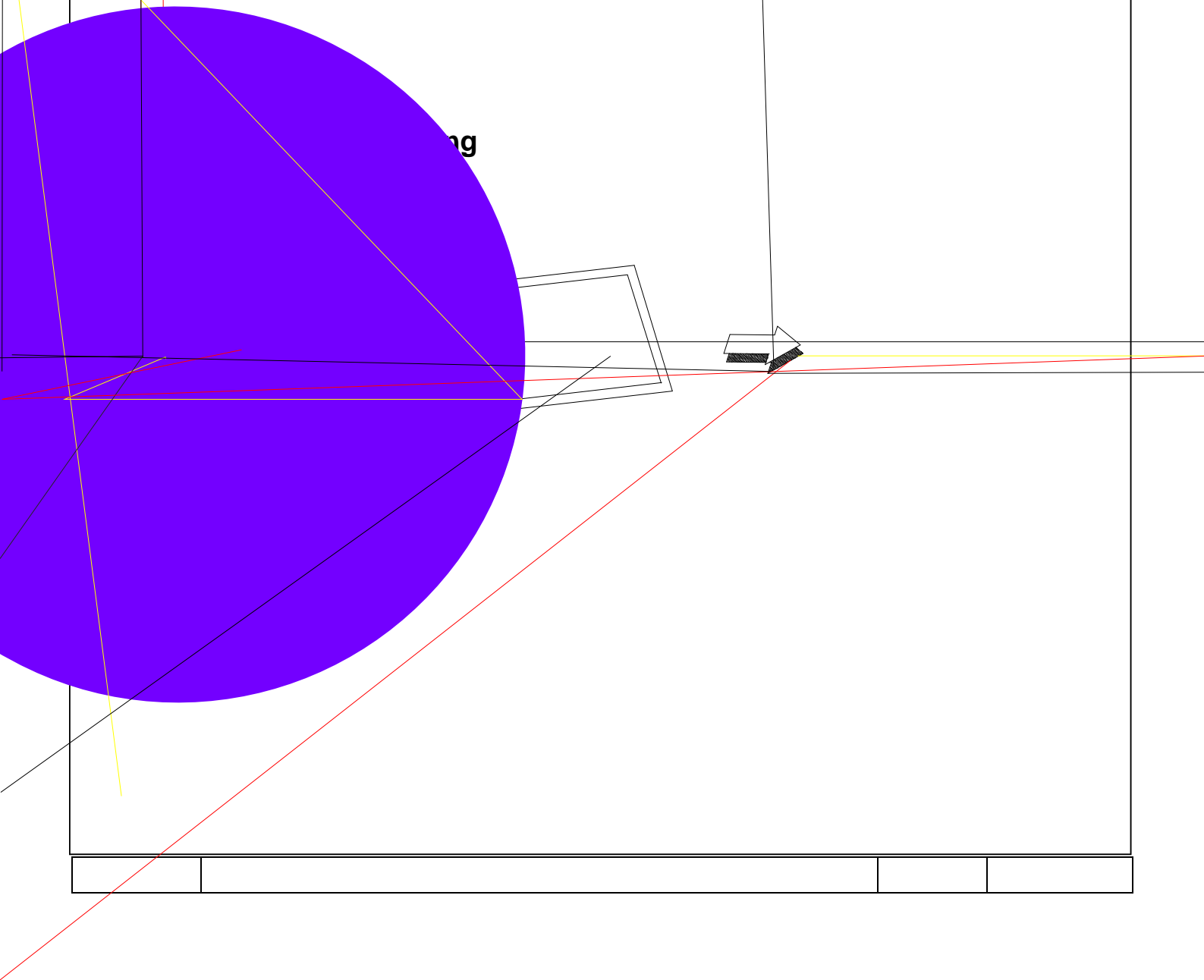

Suggest IR Reflow Condition For Lead Free

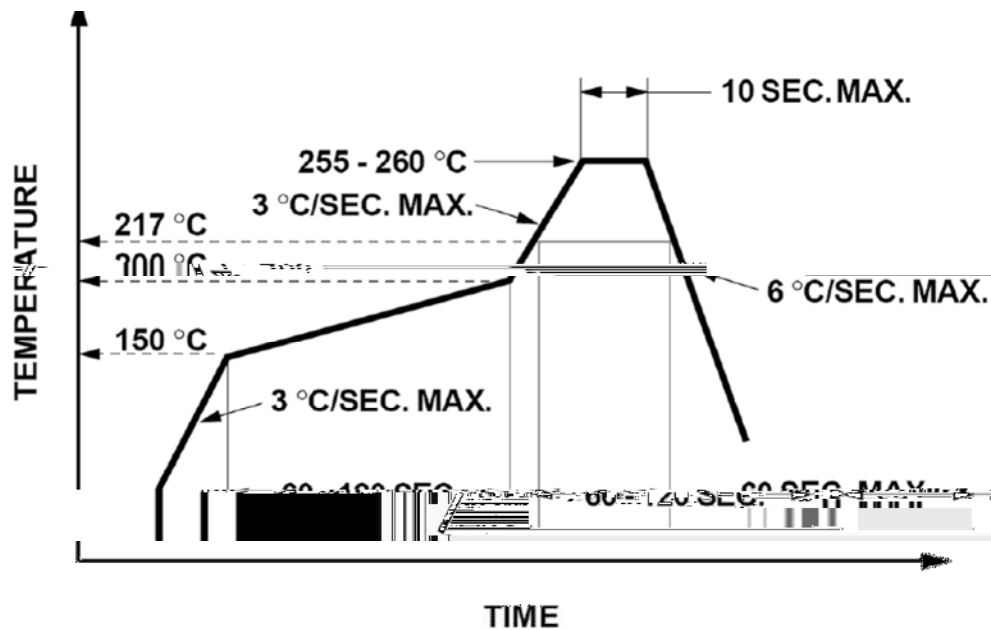

1. Reflow soldering should not be done more than two times.
2. When soldering, do not put stress on the LEDs during heating.

Soldering iron

1. When hand soldering, the temperature of the iron must less than 300°C for 3 seconds.
2. The hand solder should be done only once.

Repairing

Repair should not be done after the LEDs have been soldered. When repairing is unavoidable, a double-head soldering iron should be used (as below figure). It should be confirmed beforehand whether the characteristics of LEDs will or will not be damaged by repairing.

