

SECRET

# LIGHT



LG-IRM2B238KSF3

PIN

IC

RoHS REACH

2.7-5.5V

TTL CMOS

( MP3 MP4, )

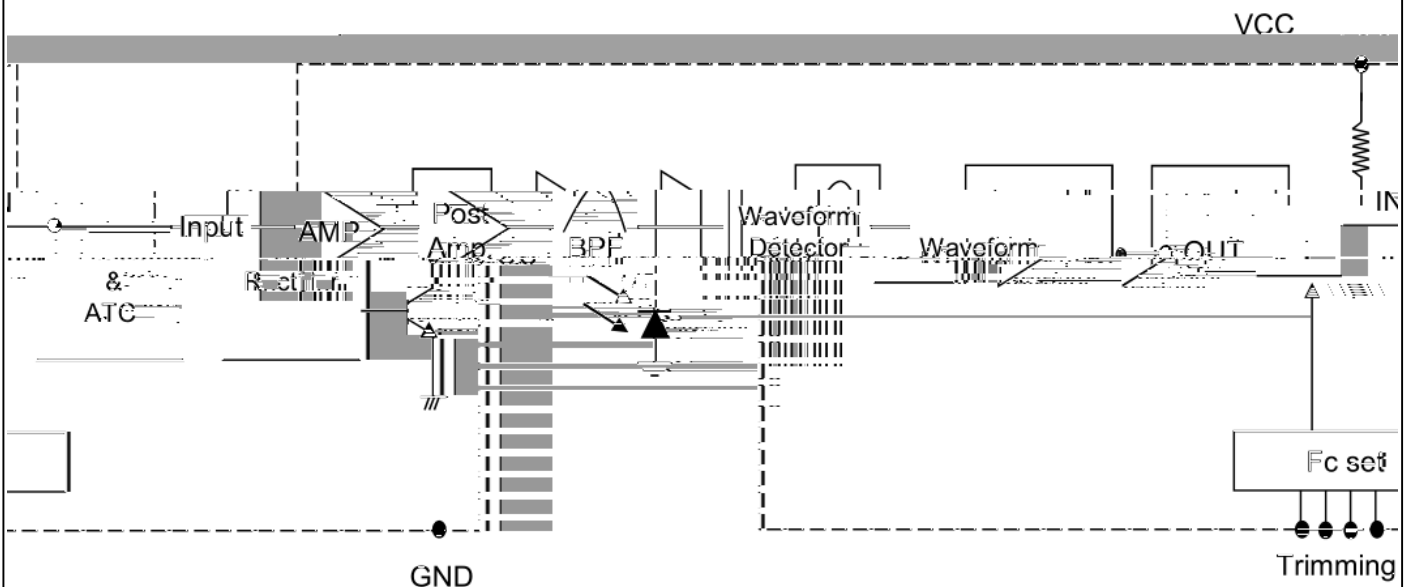
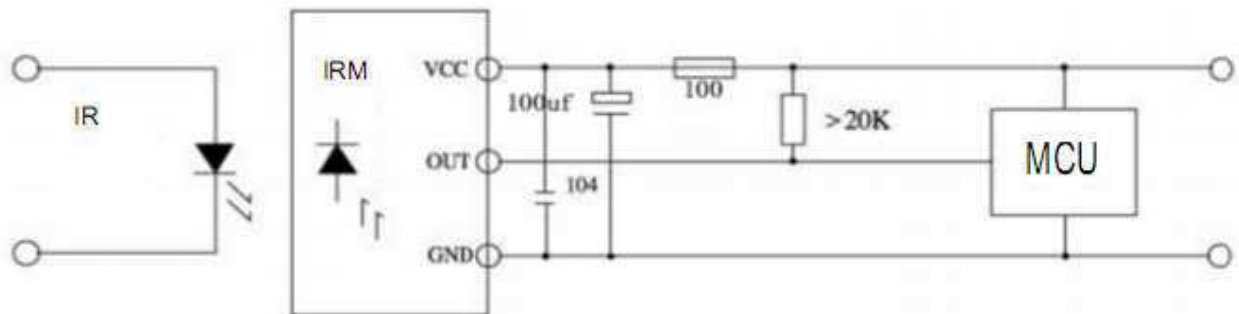
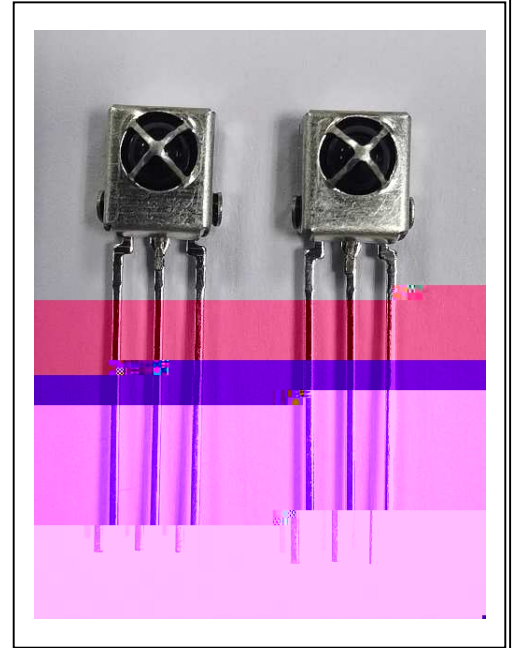

		Min	Typ	Max				
Icc		No Input Signal			0.2	0.5	0.7	mA
L	0°	16	18	---	m			
	45°	8	9	---				
	45°	8	9	---				
f <sub>0</sub>		---	37.9	---	kHz			
BPF	fbw	fin=37.9kHz			---	7.0	---	kHz
BPF	fc	---	-5	f <sub>0</sub>	+5	%		
Vol		Iosink=2.0mA			---	0.2	0.4	V
Voh		---			4.8	5.0	---	V
Av_max		fin=37.9kHz			60	64.5	68	dB
Rpul		---			---	50	---	k
Tpw		Vin =500 pp			400	600	800	μS

1m 40W

200±50Lux

Toshiba/NEC/Mitsubishi/RC5\_Philips/Sony 12bit/Zenith/RC6/Continuous Code/Sony 15bit/  
Sony 20bit/RCA/RCMM.

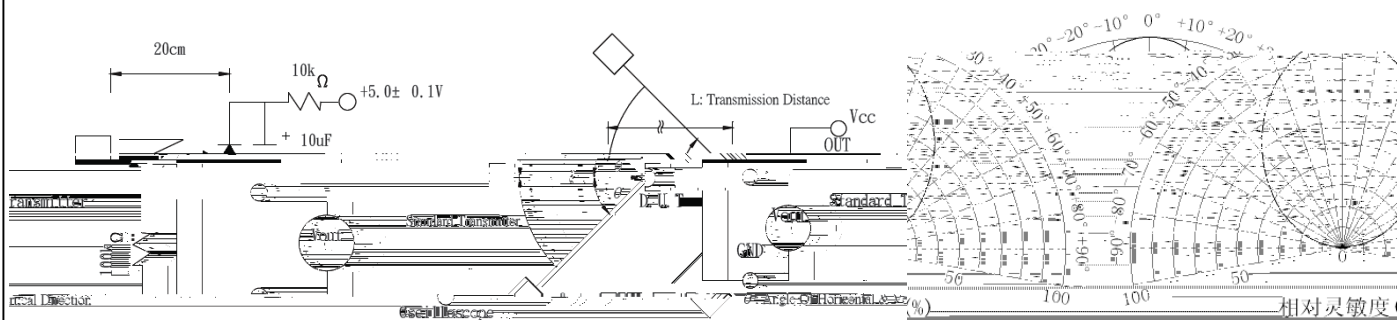

	Min.	Typ.	Max.	
V <sub>DD</sub>	2.7	---	5.5	V
FM	---	37.9	---	kHz
Topr	---	25	---	

	V <sub>DD</sub>	6.0	V
	Tstg	-40~100	
	Tsol	260±5 5S	

\* ( ) 1

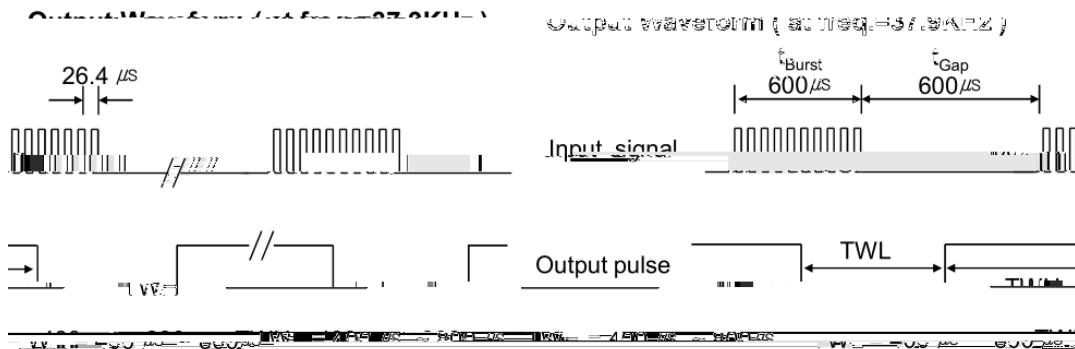

\*  $t_{pi} \geq 10/f_0$  is recommended for optimal function.

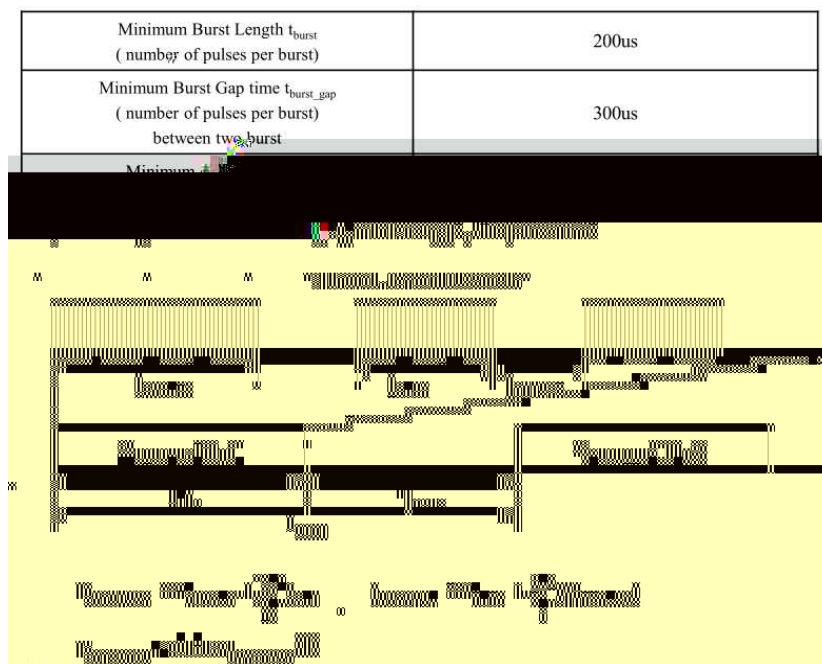

	260 ±5	5	20	20
	100PF, 1.5k , 4KV,	---	20	20
	10-50Hz/1min 1.5mm X Y Z/30min	30	20	20
	85 ±3	240	20	20
	-20 ±3	240	20	20
	85 85%	240	20	20
	-20 30 85 30	10	20	20
	2.5N 2	---	20	20

LIG

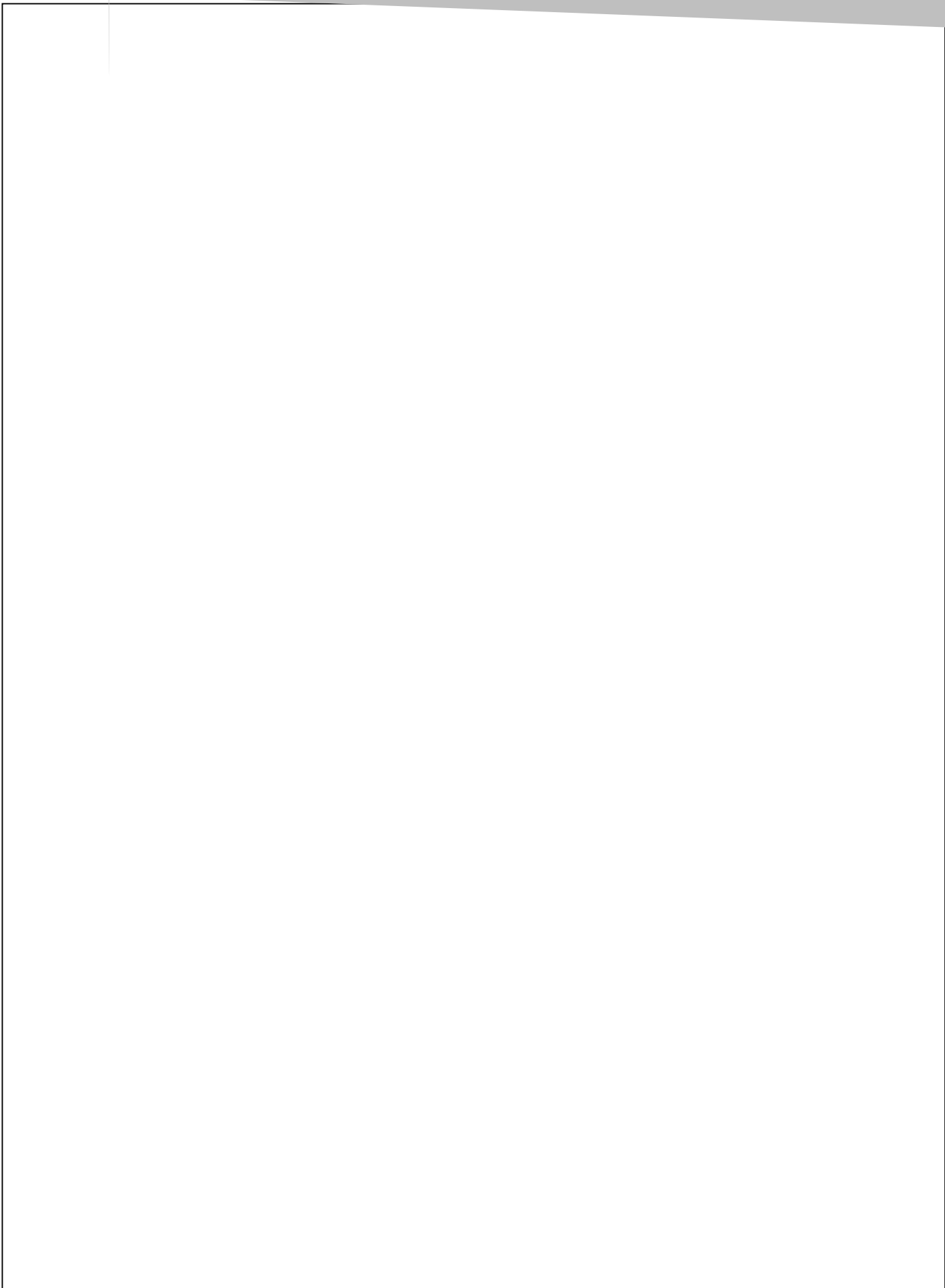

--	--	--	--

1

150mm × 190mm

500PCS

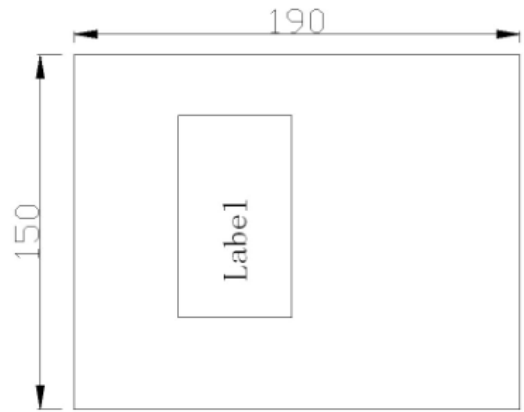

2

500pcs/

10 /

4 /

