

**LIGHT ELECTRONICS CO., LTD.**



<b>Part No.</b>	<b>LG-IRM2A438KSF3</b>		
-----------------	------------------------	--	--

1

IRM2A438 SF3                      PIN  
 IC,  
 REACH    RoHS

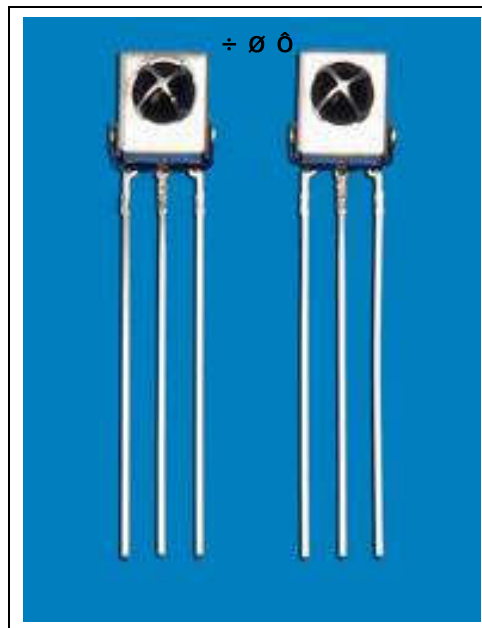

2

2.7-5.5V

3

TTL CMOS  
 :  
 (    MP3    MP4, 5, 6    ç è  
 é ê ë    ì í î    é ê í ç ì  
 ò ñ    ò

4    0 0 :

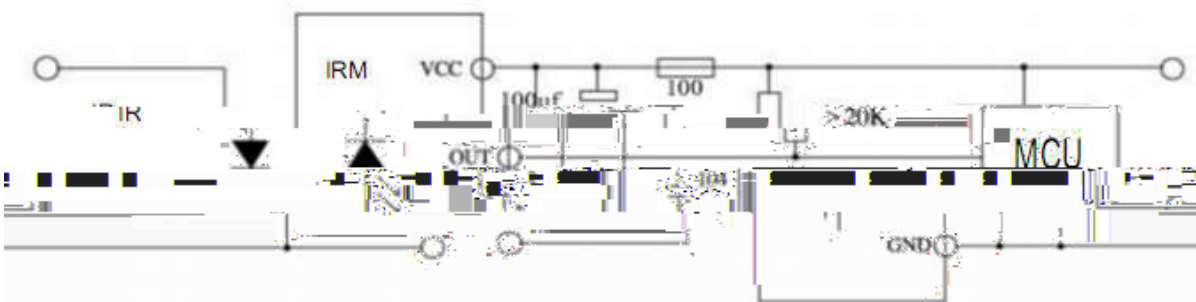

5    0 0 0

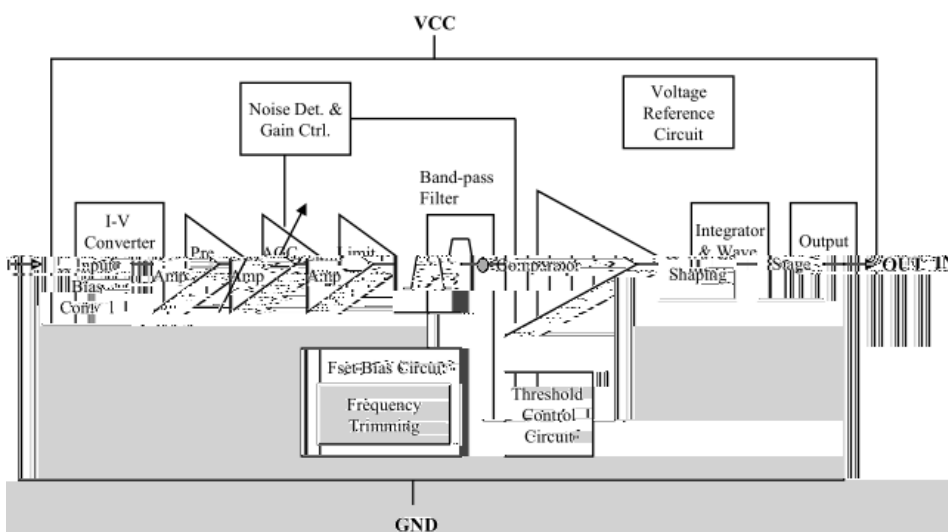

**LIGHT ELECTRONICS CO., LTD.**

L

**LIGHT ELECTRONICS CO., LTD.**

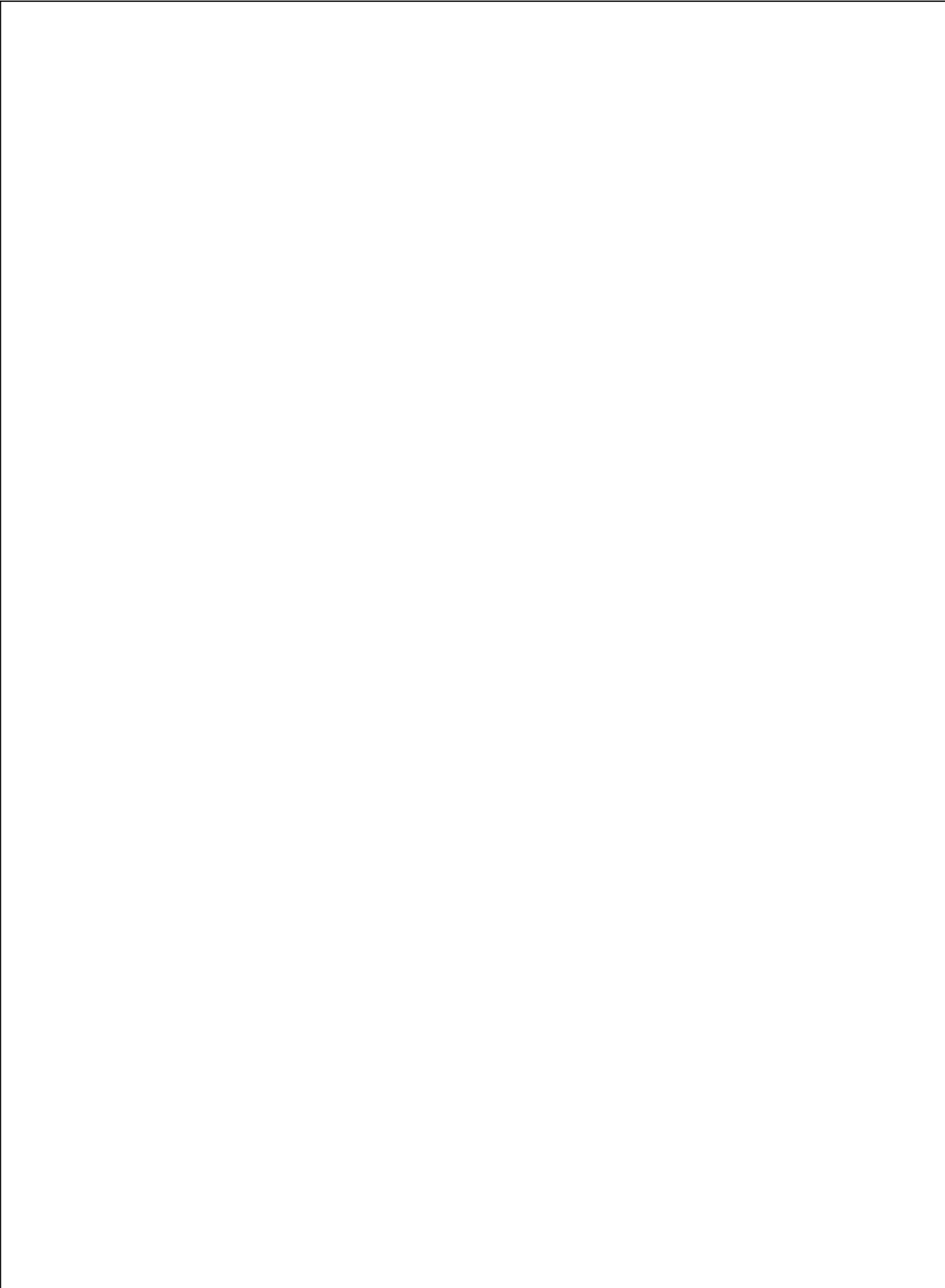

1a

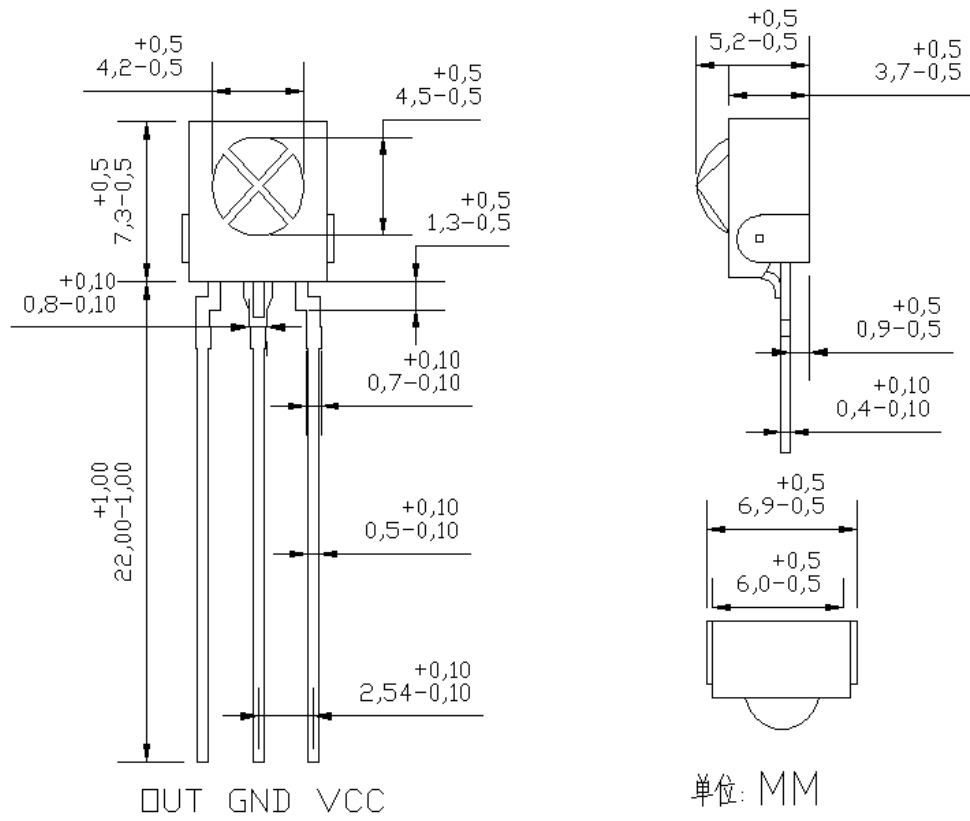

15

1è.

: 26pü 5

2

3a

16.

1è.      ë      ô ï

ú      5pPCS

2è.

ô

ú      5pPCS

1p

ã

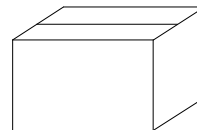
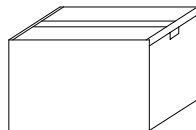
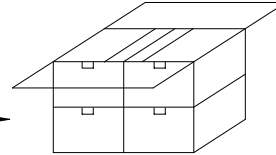
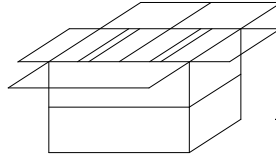
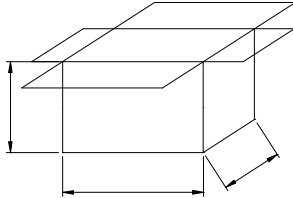
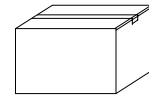
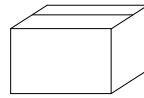
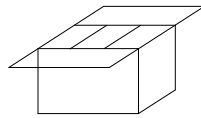
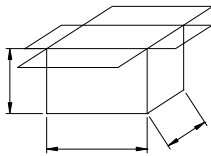
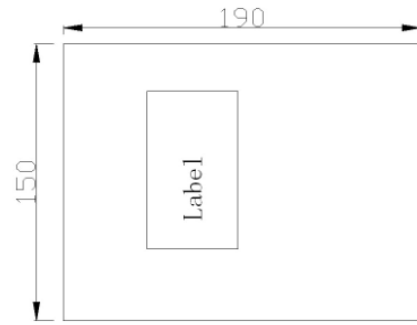

(pcs / )	( / )	( / )
<b>500</b>	<b>10</b>	<b>4</b>