

# **SL-T0603GEC005-L40**

\_\_\_\_\_  
\_\_\_\_\_  
\_\_\_\_\_

### Features

- ◆ Pb free product—RoHS compliant
- ◆ Low power consumption, High efficiency
- ◆ Reliable and rugged
- ◆ Long life – solid state reliability
- ◆ Viewing Angle: 120°

### Package Dimension

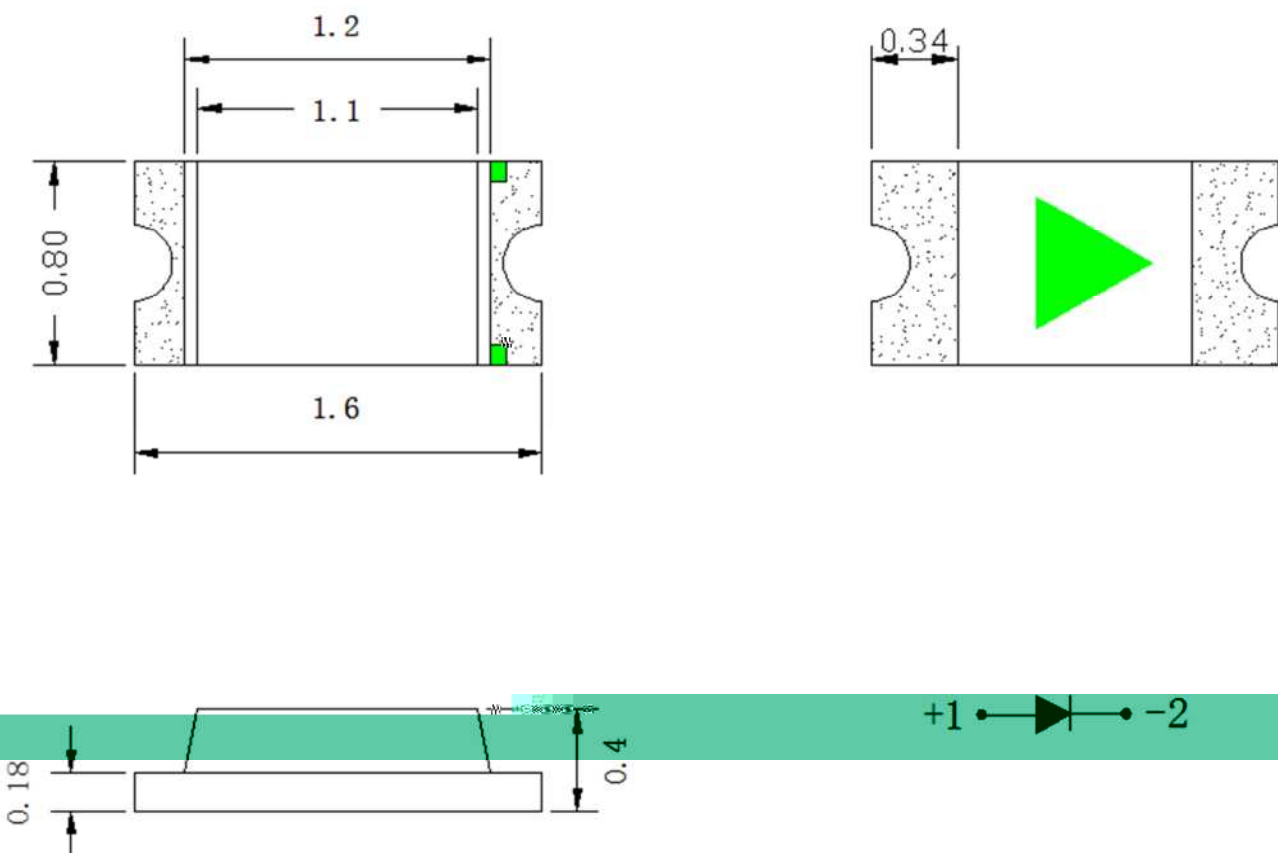

Part NO.	Lens Color	Source Color
SL-T0603GEC005-L40	Water Clear	Green

#### Notes:

1. All dimensions are in millimeters.
2. Tolerance is  $\pm 0.10\text{mm}$  unless otherwise noted
3. Specifications are subject to change without notice.



### Absolute Maximum Ratings at Ta=25

### Electrical Optical Characteristics at Ta=25

Viewing Angle	2					
Dominant Wavelength	d	520	---	530	nm	I
Peak Emission Wavelength	p	---	515	---	nm	I

**Note:**

The dominant wavelength, d is derived from the CIE chromaticity diagram and represents the

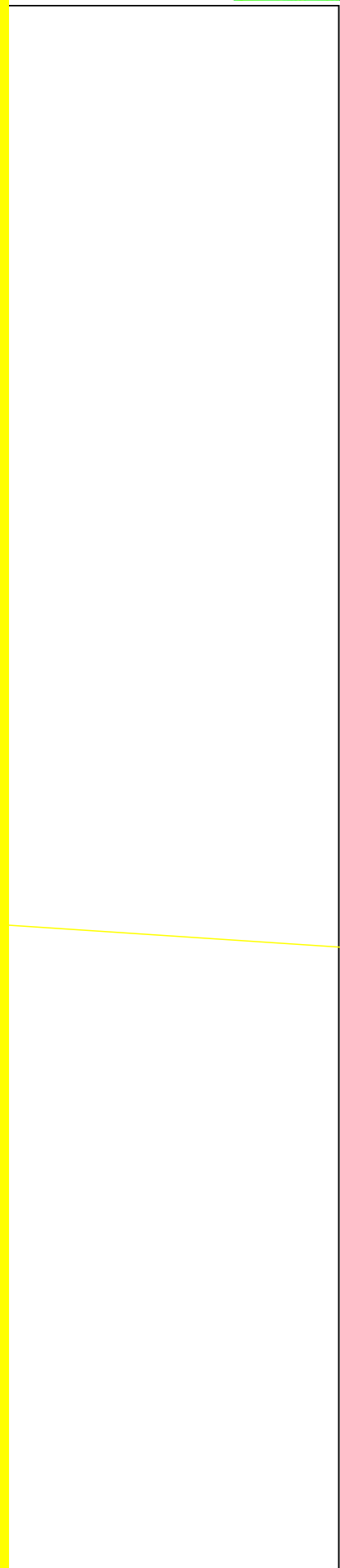
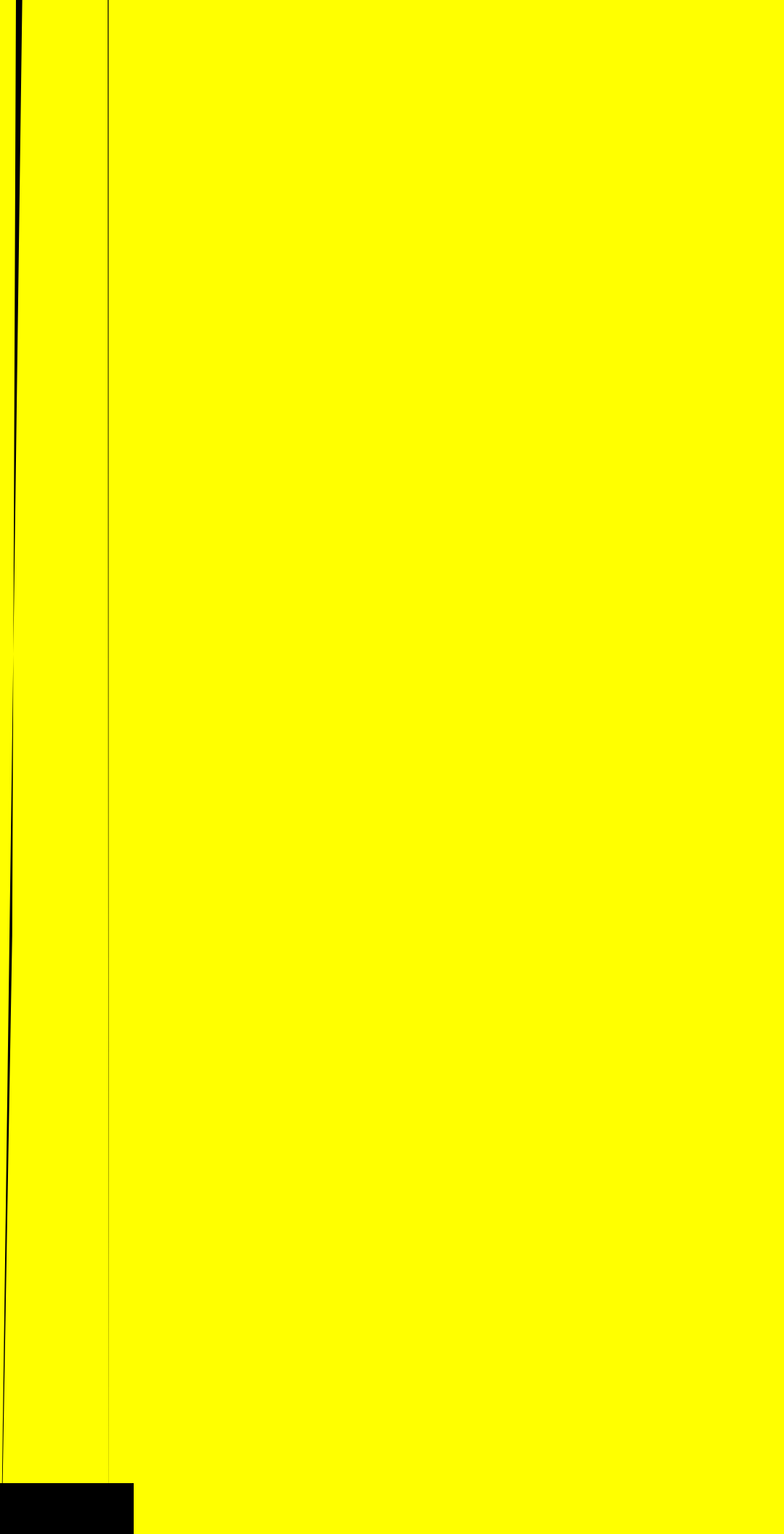

T



Explanation

**LIGHT**  
Light Electronics CO., LTD.

MODEL NAME: \_\_\_\_\_

QUANTITY: \_\_\_\_\_

BI N: \_\_\_\_\_

PACKING DATE: \_\_\_\_\_

REMARKS: \_\_\_\_\_

LOT NO. : 

**LIGHT**  
Light Electronics CO., LTD.

MODEL NAME: \_\_\_\_\_

QUANTITY: \_\_\_\_\_

BI N: \_\_\_\_\_

PACKING DATE: \_\_\_\_\_

CUSTOMER P/N: \_\_\_\_\_

LOT NO. : 

Dimensions

Note:

**Carrier Tape Specifications (Loaded Quantity: 4000pcs/reel)**

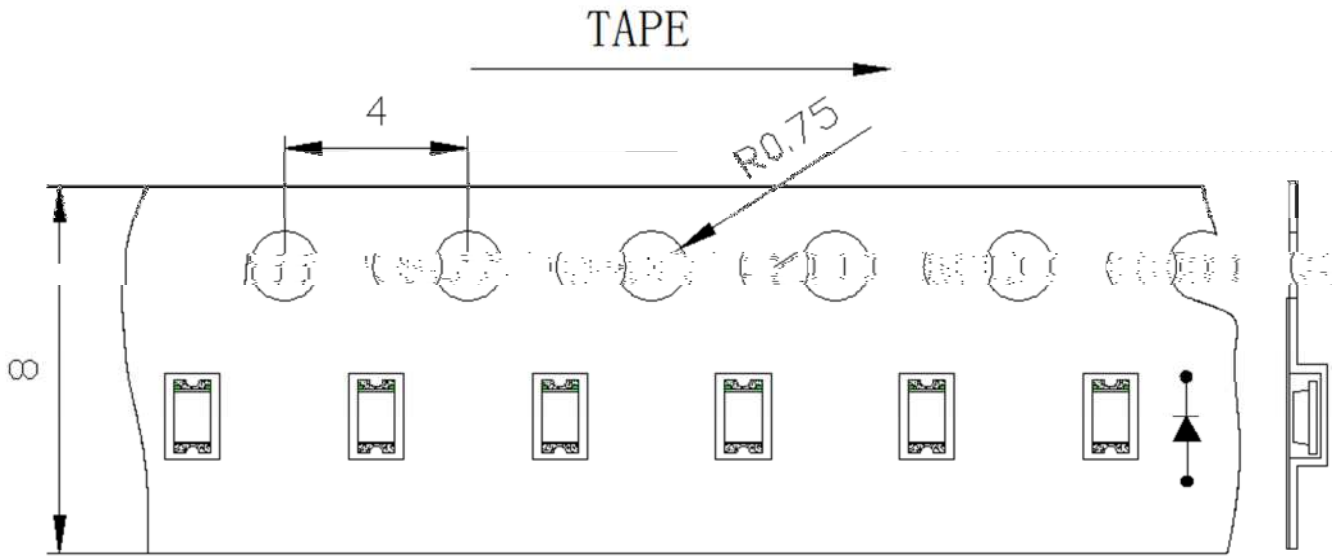

**Moisture Resistant Packaging**

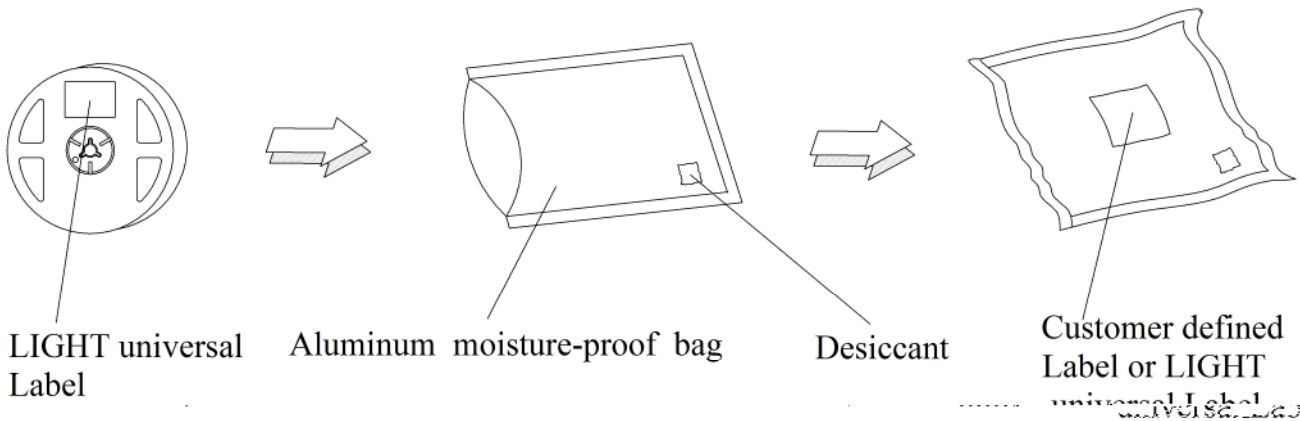

## Suggest IR Reflow Condition For Lead Free

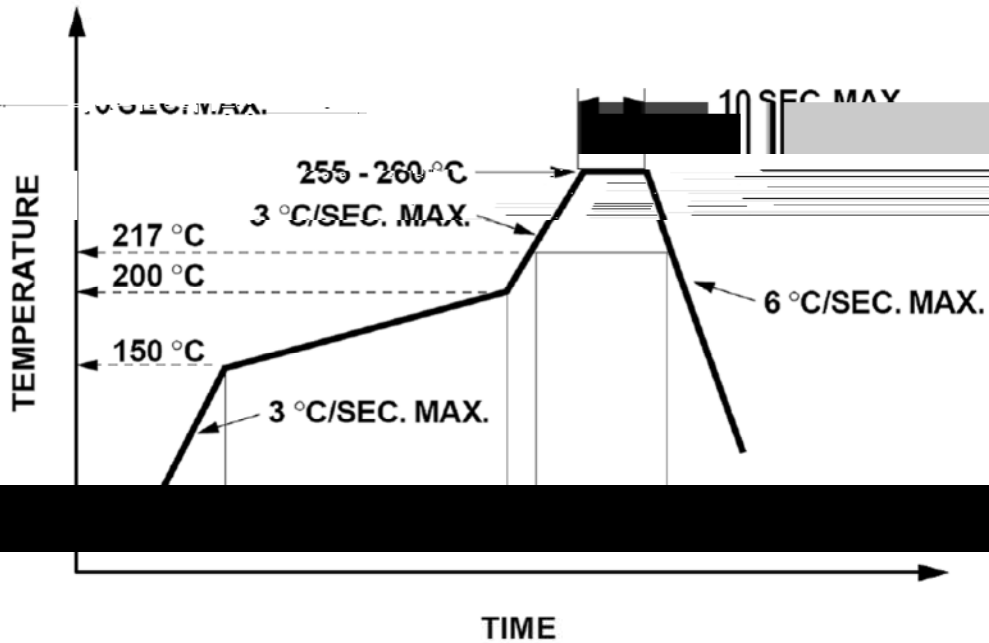

1. Reflow soldering should not be done more than two times.
2. When soldering, do not put stress on the LEDs during heating.

### Soldering iron

1. When hand soldering, the temperature of the iron must less than 300°C for 3 seconds.
2. The hand solder should be done only once.

### Repairing

Repair should not be done after the LEDs have been soldered. When repairing is unavoidable, a double-head soldering iron should be used (as below figure). It should be confirmed beforehand whether the characteristics of LEDs will or will not be damaged by repairing.

