

# **SL-T2528RGBIC-L110**

## **DATA SHEET**

SPEC.NO. : SZ18092602  
DATE : 2018/09/26  
REV. : A/0

Approved By:

Checked By:

Prepared By:

# LIGHT



% ..... '

& ..... '

' ..... '

( ..... ('

) ..... ''





\*" D] b Zi bVh] cb

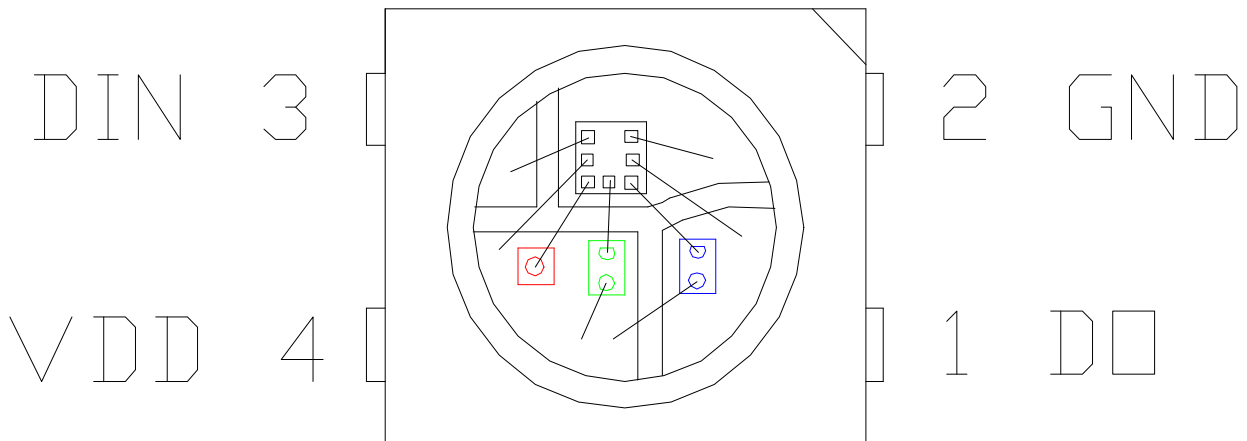

%	8C		
&	; B8		
'	8=B		
(	J88		D76

+ " 9` YVhf c! cdh] WU` VXUF UWhYf] gh] Vg Uh HU1&) F; 6

=hYa	GraVc`	A]I	Hrd	AUI	I b] h	7cbX] h] cbg
8ca] bUbh kUj Y` Yb[ h\	E` X	; )&\$		)&	ba	=: 1%&a5
		F *&\$		*&		
		6 (*)		(+\$		
@ a] bci g ] bhYbg] hm	=J	; , \$\$		%&\$\$	aVK	=: 1%&a5
		F &\$\$		(\$\$		
		6 % \$		' \$\$		

L

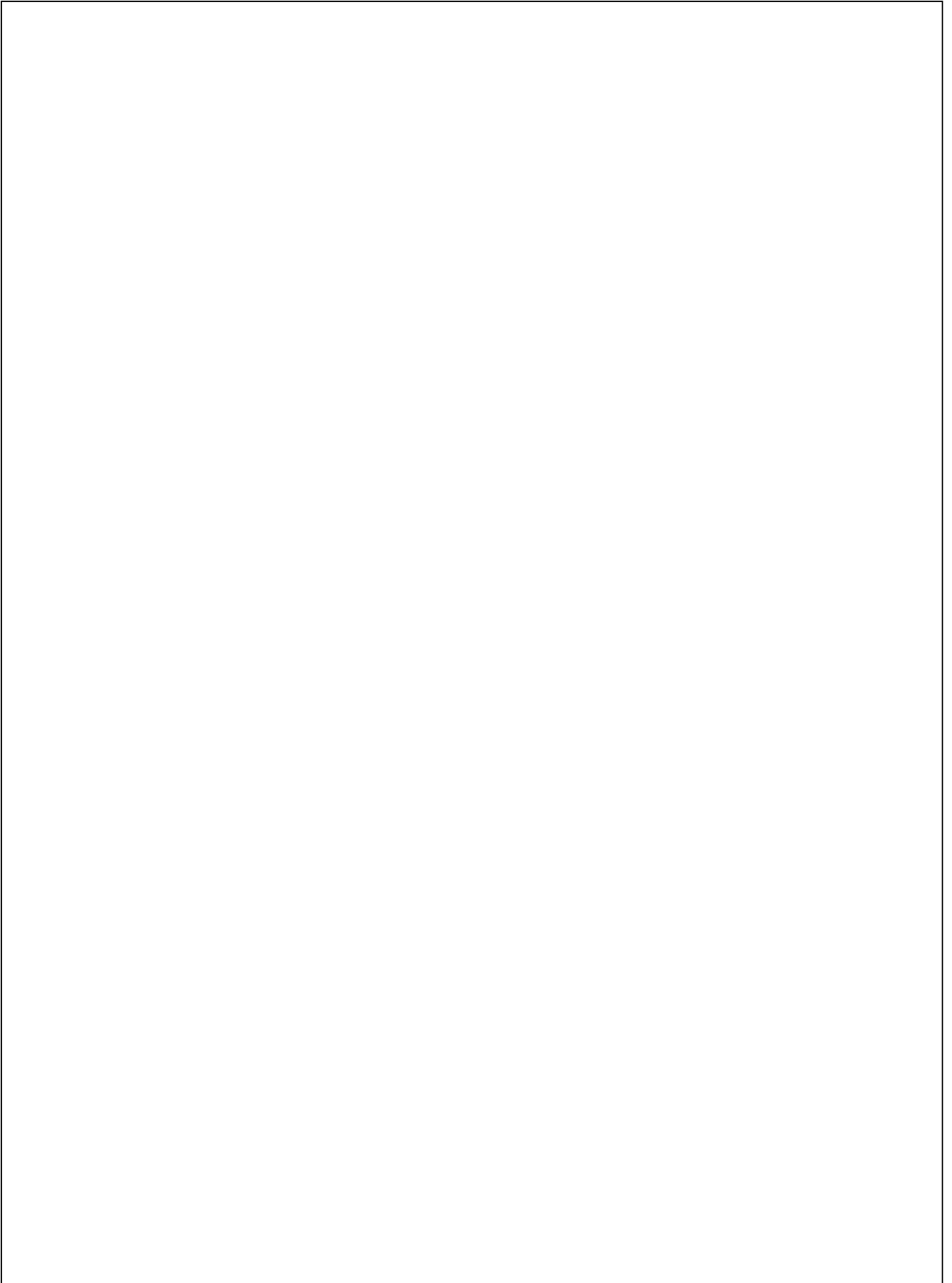

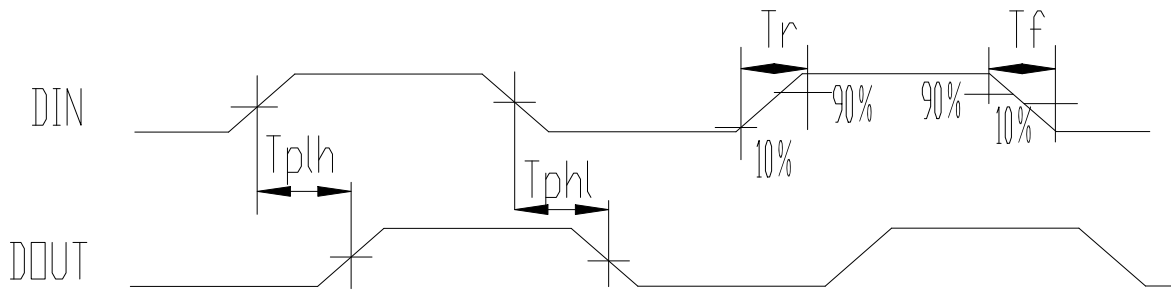

%% H\Y XUhU hfUbga] gg] cb h] aY

&) & F; 6=7					
H	7cXY	A] b	Hnd] W	AU	l b] h
HC<	\$	&()	&-)	'()	bg
HC@	\$	)()	)-)	*()	bg
H%<	%	)()	)-)	*()	bg
H%@	%	&()	&-)	'()	bg
Hfgh	FYgYh	, \$	!!	!!	i g

%%" HYadcfU` kUj YZcfa Z][i fY

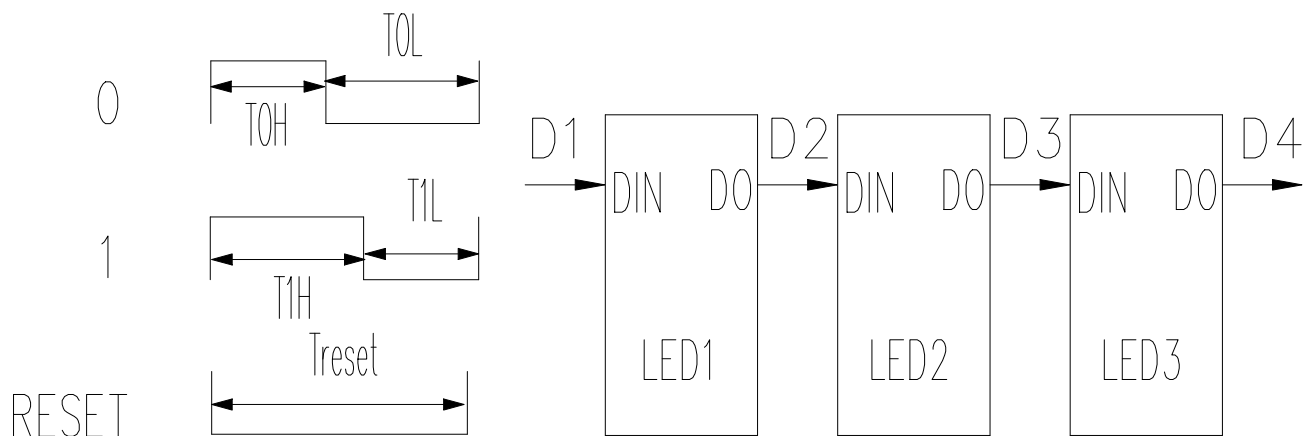

% " AcXY cZ XUhU hfUbga] gg] cb

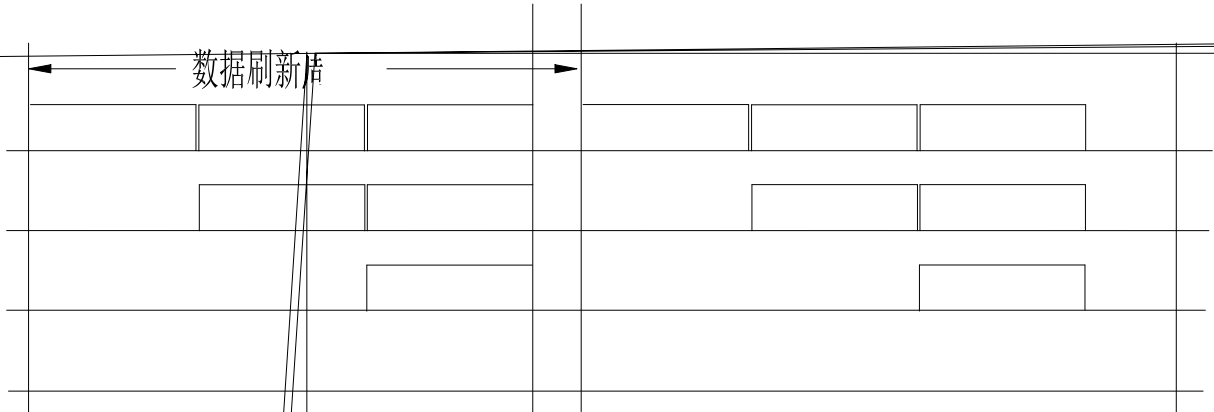

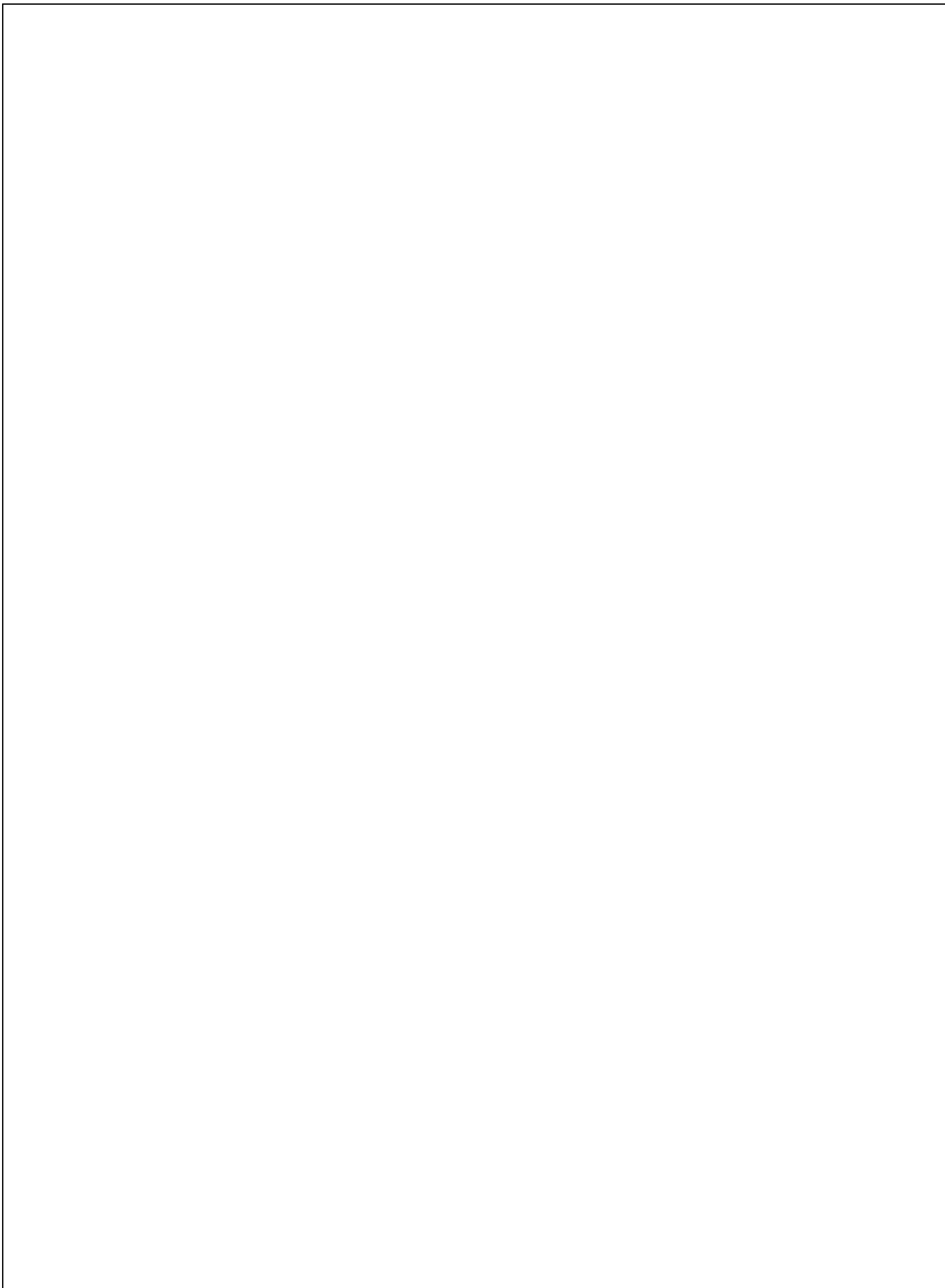

LIG

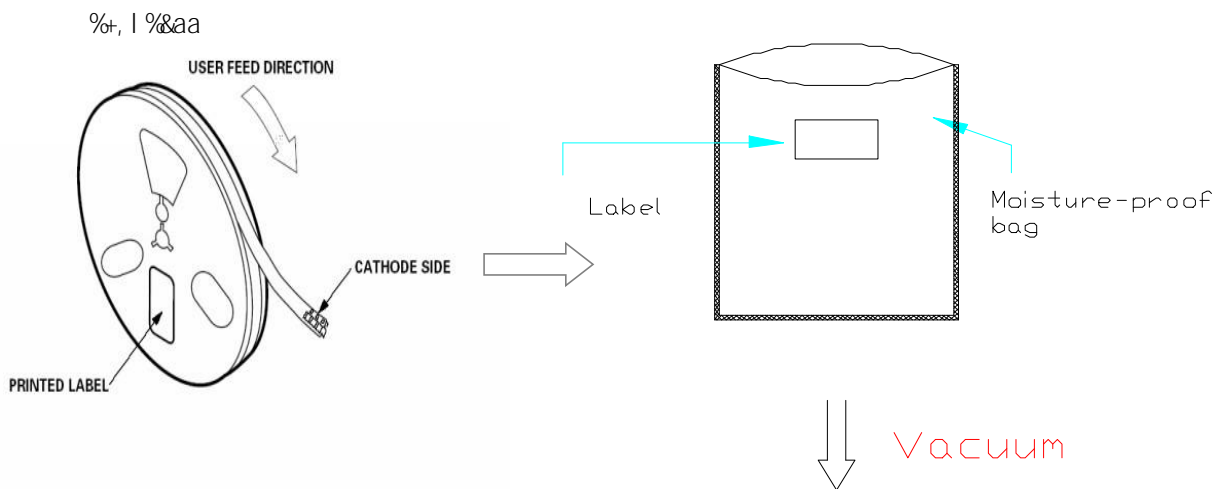
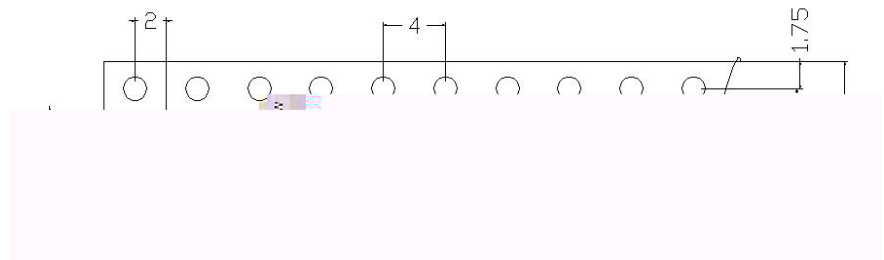

%" DUW\_U[ ] b[ GdYV\ Z] W\h] cbg

: YXX] b[ 8] fYVh] cb



<b>LIGHT</b>		
Light Electronics CO., LTD.		
MODEL NAME: _____	 LOT NO.: _____	
QUANTITY: _____		
BIN: _____		
PACKING DATE: _____		
CUSTOMER P/N: _____		

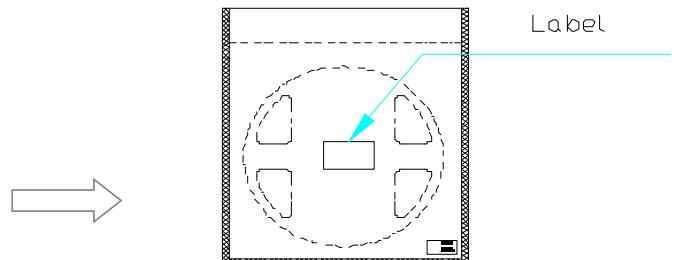

BchY. jc`iaY ]g &\$\$\$dVg/

&\$\$\$dVg

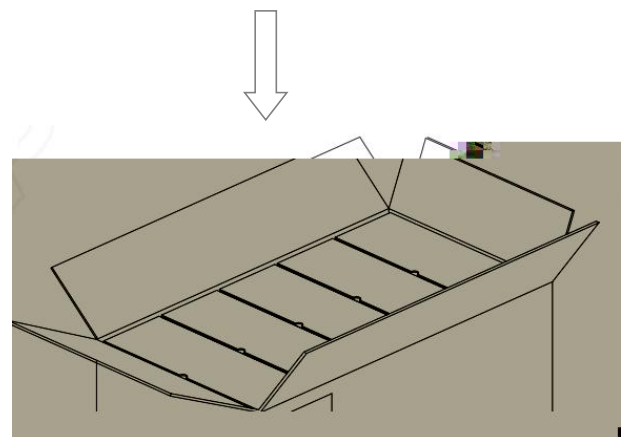

% " FY` ]U]` ]hm

H9GH =H9AG 5B8 F9GI @HG

	HYgh =hYa	FYZ" GhUbXUfX	HYgh 7cbX] h] cbg	BchY	7cbWi g] cb
%	FYZ` ck Gc` XYf] b[	>9G8&&! 6%\$*	Hg` X1&(\$ ž%\$gYW	' h] aYg	\$#&&
&	HYadYfUhi fY 7mWY	>9G8&&! 5%\$(	! &\$ ' \$a] b %&\$ ' \$a] b	&\$ \$ WmWY	\$#&&
,	HYfaU` G\cW_	>9G8&&! 5%\$*	! (\$ %&a] b %&) %&a] b	&\$ \$ WmWY	\$#&&
(	<][\ HYadYfUhi fY GhcfU[Y	>9G8&&! 5%\$'	H,1%\$\$	%\$\$\$ \fg	\$#&&
)	@ck HYadYfUhi fY GhcfU[Y	>9G8&&! 5%%	H,1! (\$	%\$\$\$ \fg	\$#&&
*	DckYf hYadYfUhi fY 7mW] b[	>9G8&&! 5%\$)	Cb) a] b! (\$ 2%&a] b 0%&a] b CZZ) a] b%\$\$ 2%&a] b	&\$ \$ WmWY	\$#&&
+	@]ZY HYgh	>9G8&&! 5%\$,	H,1&) = 1%&a5	%\$\$\$ \fg	\$#&&
,	<][\ <i a] X] hm <YUh @]ZY HYgh	>9G8&&! 5%\$%	*\$ F<1- \$i = 1%&a5	%\$\$\$ \fg	\$#&&

% " FYZ` ck dfcZ]` Y

GAB FYZ` ck Gc` XYf] b[ =bghfi Vh] cbg

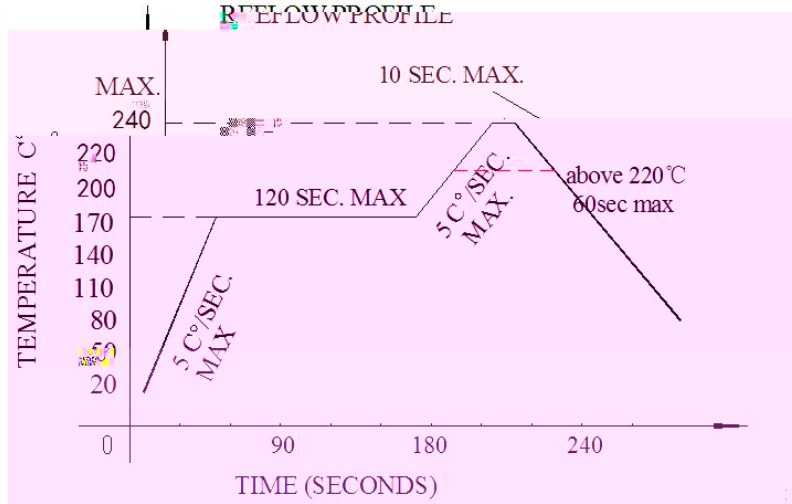

U" FYZ` ck gc` XYf] b[ g\ci` X bch VY XcbY acfY h\Ub hkc h] aYg

&

V" K\Yb gc` XYf] b[ žXc bch di h ghfYgg cb h\Y @98g Xi f] b[ \YUh] b[

@98

Gc` XYf] b[ ] fcb

U" K\Yb \UbX gc` XYf] b[ ž \_YYd h\Y hYadYfUhi fY cZ h\Y ] fcb i bXYf ' \$\$ ž UbX Uh h\Uh

hYadYfUhi fY \_YYd h\Y h] aY i bXYf ' gYW

' \$\$

V" H\Y \UbX gc` XYf] b[ g\ci` X VY XcbY cb` m U h] aY

FYkcf\_

U" 7i ghcaYf ai gh Z] b] g\ fYkcf\_ k] h\] b ) gYWi bXYf & (\$

& (\$ )

V" H\Y \YUX cZ ] fcb WUb bch hci WX h\Y @98g

@98

W Hk] b! \YUX hmdY ] g dfYZYffYX"

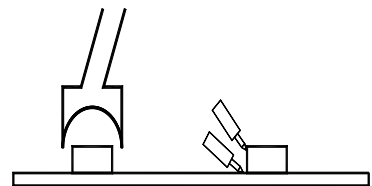





LIGH

