

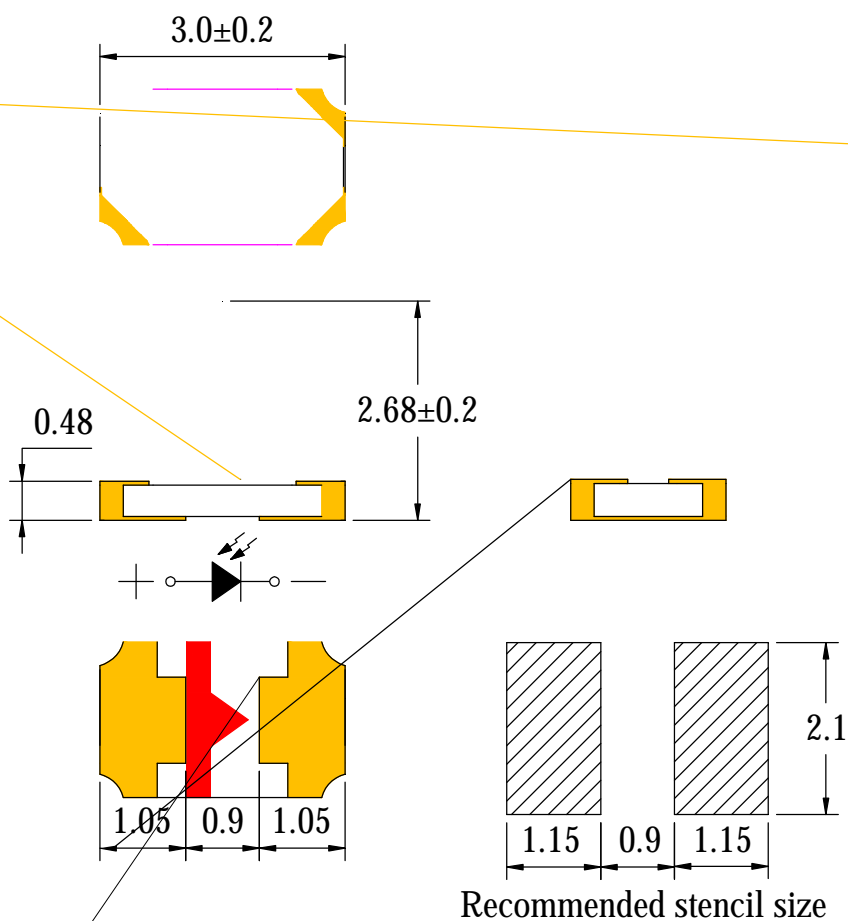

Features

- Pb free product—RoHS compliant
- High Photo Sensitivity
- Reliable and rugged
- Long life – solid state reliability
- Sensitivity angle: 85°

Package Dimension



Part NO.	Chip Material	Lens Color
SL-T3020PDB020-L268-F-S	Silicon	Black

Notes:

1. All dimensions are in millimeters.
2. Tolerance is ± 0.10 mm unless otherwise noted.
3. Specifications are subject to change without notice.



Typical Electrical / Optical Characteristics Curves
(25 Ambient Temperature Unless Otherwise Noted)

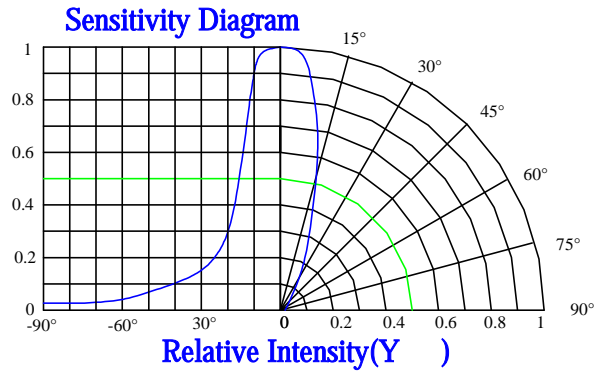
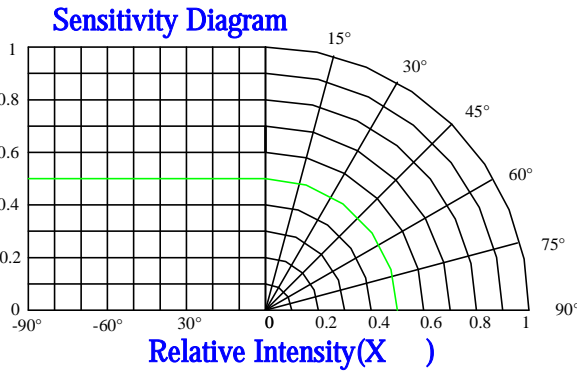
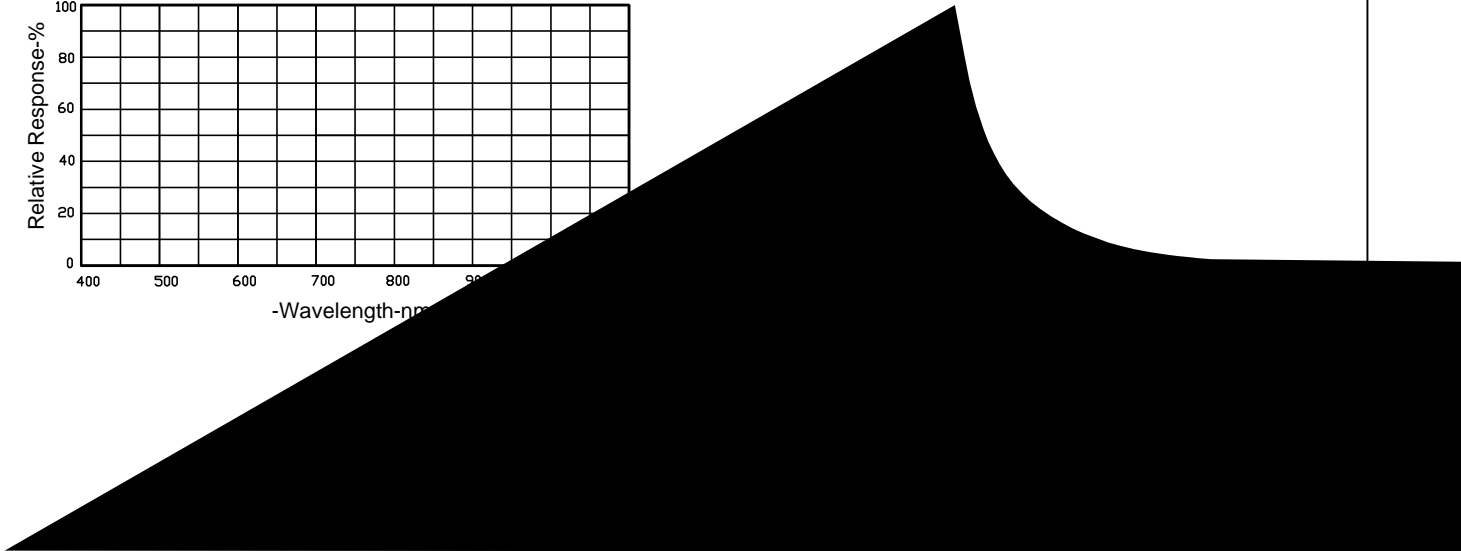
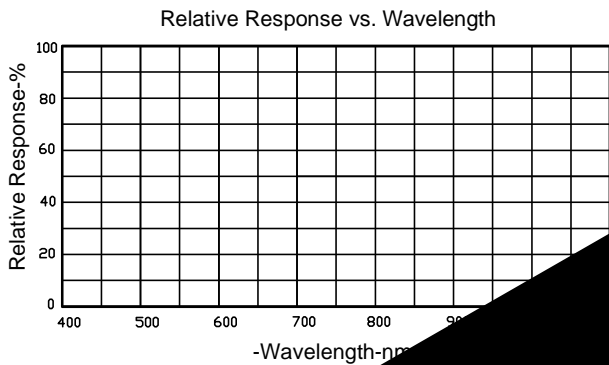





Reverse Light Current(I_L) Bin Code ($V_R=5V$, $E_e=1mW/cm^2$)

BIN CODE	Min.(μA)	Max.(μA)
26	9.2	11
27	11	13
28	13	15.5
...

NOTE: The I_L guarantee should be added $\pm 15\%$ tolerance.

Label Explanation

LIGHT	
A	

LIGHT	
_____	

Carrier Tape Specifications (Loaded Quantity: 5000pcs/reel)

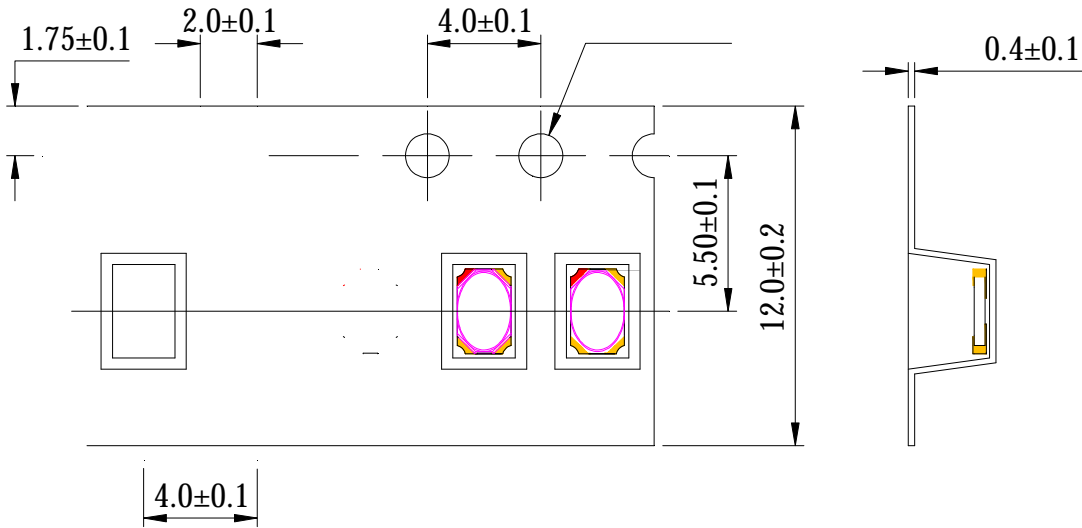

Note: Tolerance unless mentioned is ± 0.1 mm; Unit = mm

Moisture Resistant Packaging

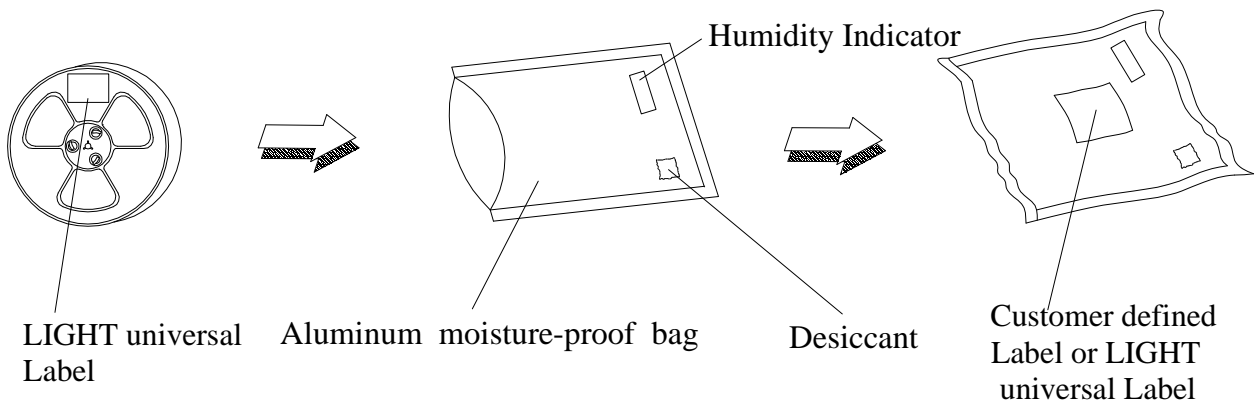

Suggest IR Reflow Condition For Lead Free

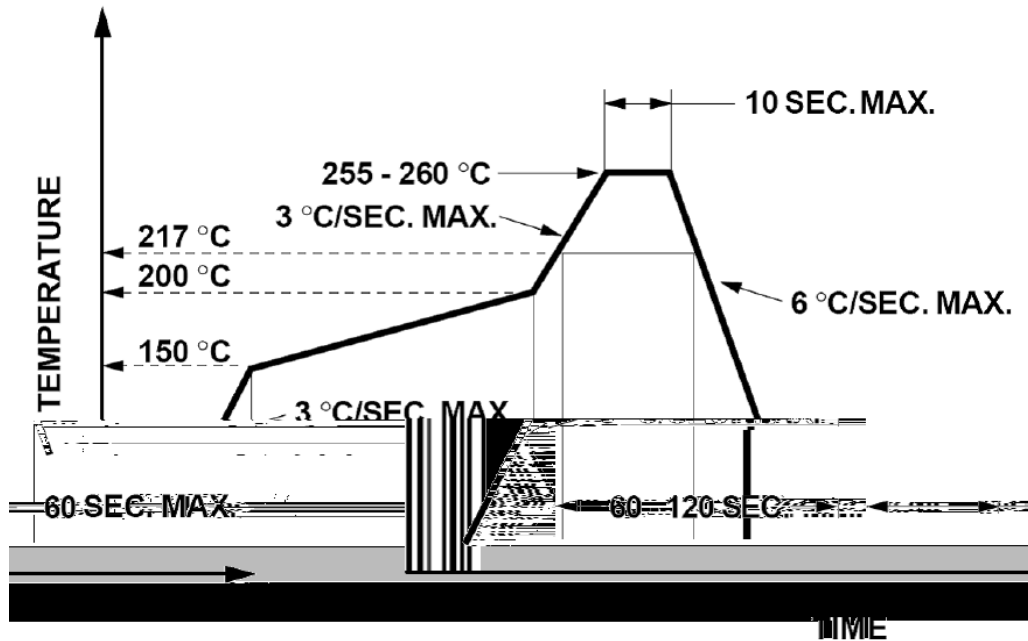

1. Reflow soldering should not be done more than two times.
2. When soldering, do not put stress on the LEDs during heating.

Soldering iron

1. When hand soldering, the temperature of the iron must less than 300 °C for 3 seconds.
2. The hand solder should be done only once.

Repairing

Repair should not be done after the LEDs have been soldered. When repairing is unavoidable, a double-head soldering iron should be used (as below figure). It should be confirmed beforehand whether the characteristics of LEDs will or will not be damaged by repairing.

