

SL-T2528RGBIC-L110

DATA SHEET

SPEC.NO. : SZ18092602
DATE : 2018/09/26
REV. : A/0

Approved By:

Checked By:

Prepared By:



% '

& '

' '

(..... ('

)

LIGHT ELECTRONICS CO., LTD.

*" D] b Zi bVh] cb

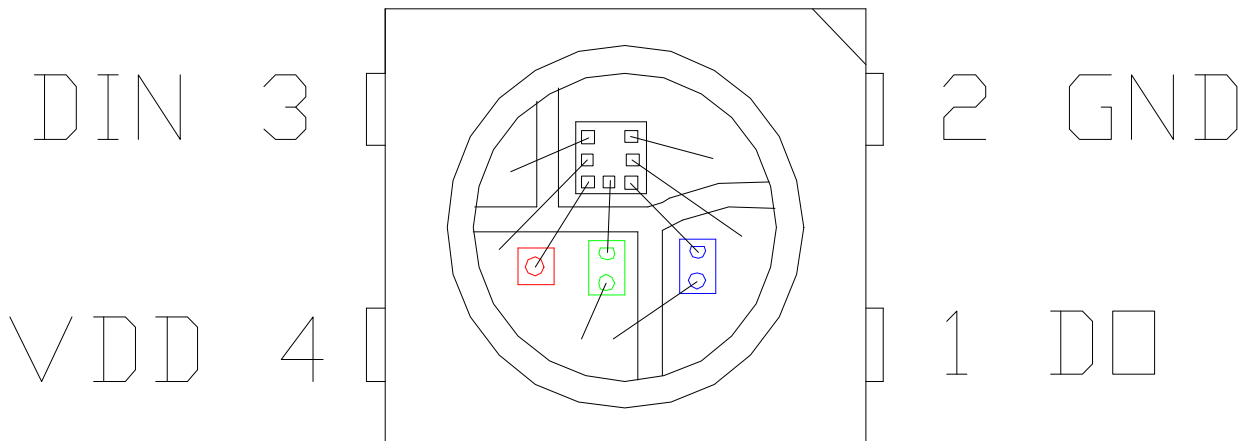

%	8C		
&	; B8		
'	8=B		
(J88		D76

+ " 9` YVhfc! cdh] WU` VXUFUVhYf] gh] Vg Uh HU1&) F; 6

=hYa	GraVc`	A]I	Hrd	AUI	I b] h	7cbX] h] cbg
8ca] bUbh kUj Y` Yb[h\	E` X	;)&\$)&	ba	=: 1%&a5
		F *&\$		*&		
		6 (*)		(+\$		
@ a] bci g] bhYbg] hm	=J	; , \$\$		%&\$\$	aVK	=: 1%&a5
		F &\$\$		(\$\$		
		6 % \$		' \$\$		

L

LIGHT ELECTRONICS CO., LTD.

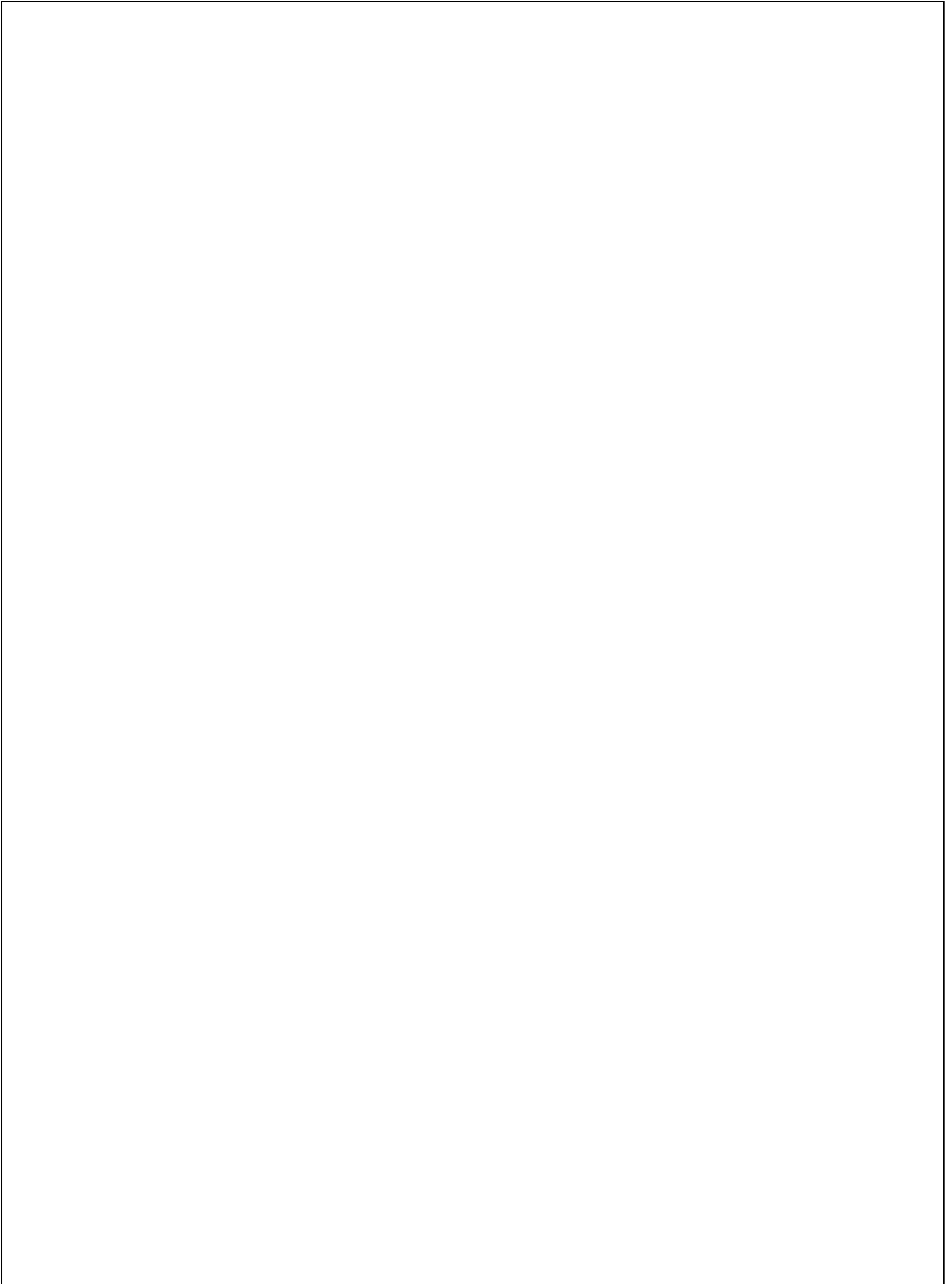

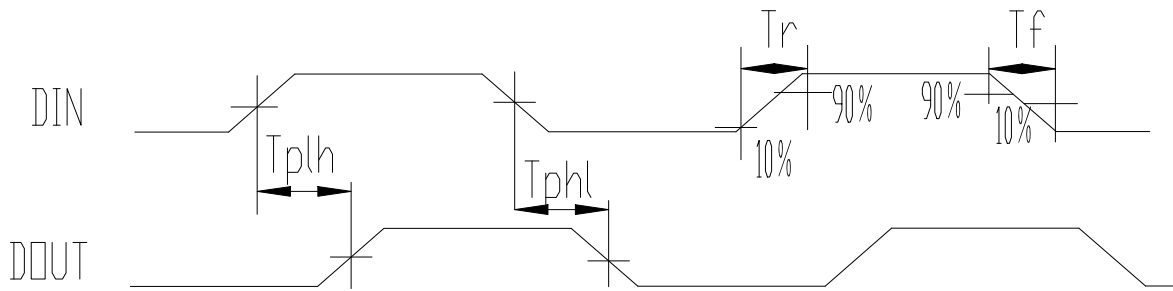

Symbolic representation of the timing diagram above.

Symbolic representation of the timing diagram above					
H	7cXY	A] b	Hnd] W	AU	l b] h
HC<	\$	&()	&-)	'()	bg
HC@	\$)())-)	*()	bg
H%<	%)())-)	*()	bg
H%@	%	&()	&-)	'()	bg
Hfgh	FYgYh	, \$!!	!!	i g

Symbolic representation of the timing diagram above.

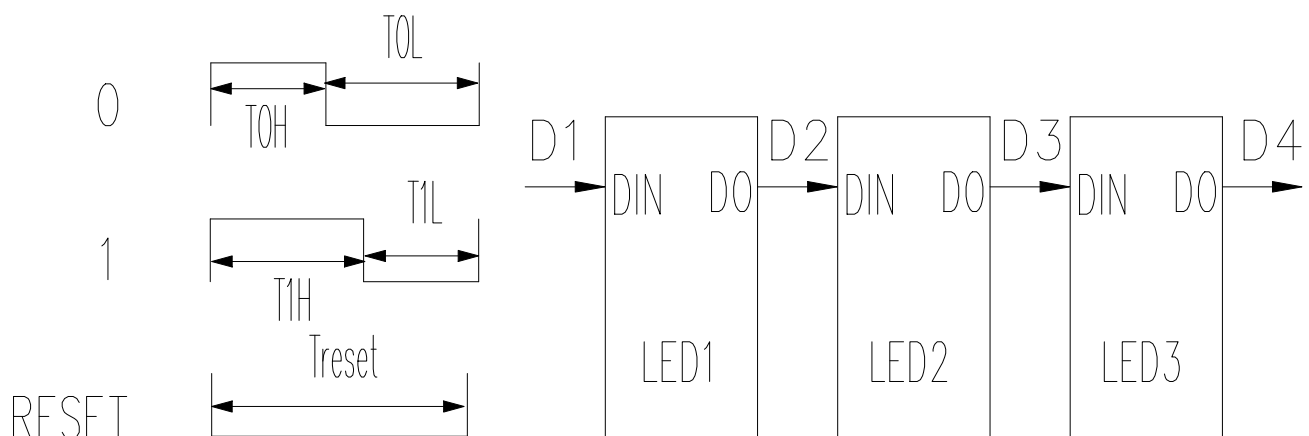

% " AcXY cZ XUhU hfUbga] gg] cb

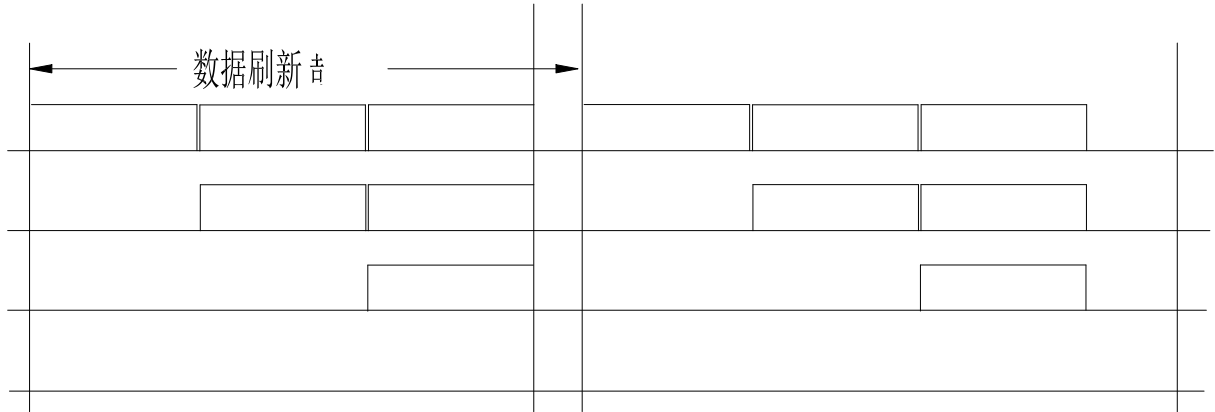

LIG

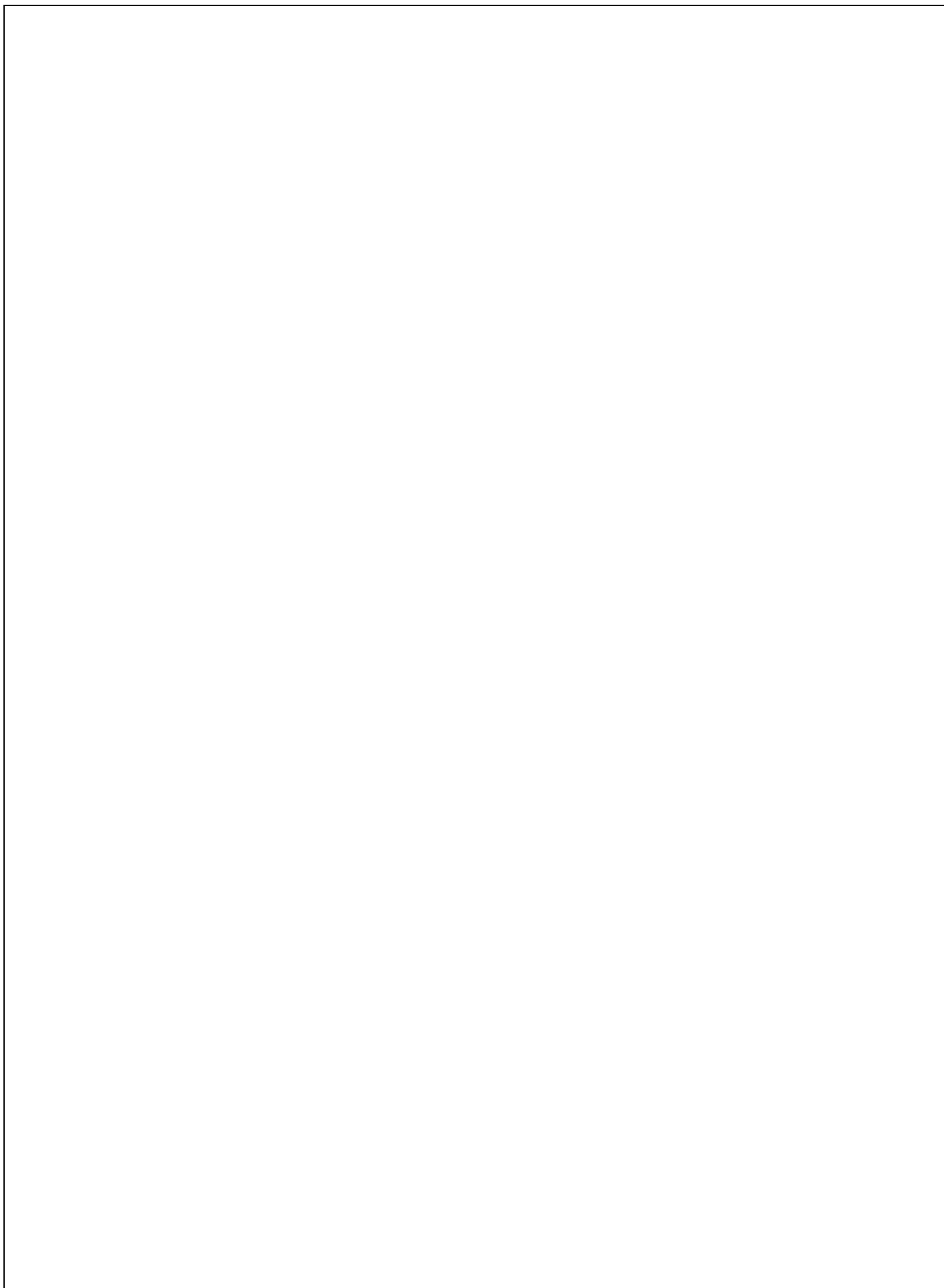

LIGHT ELECTRONICS CO., LTD.

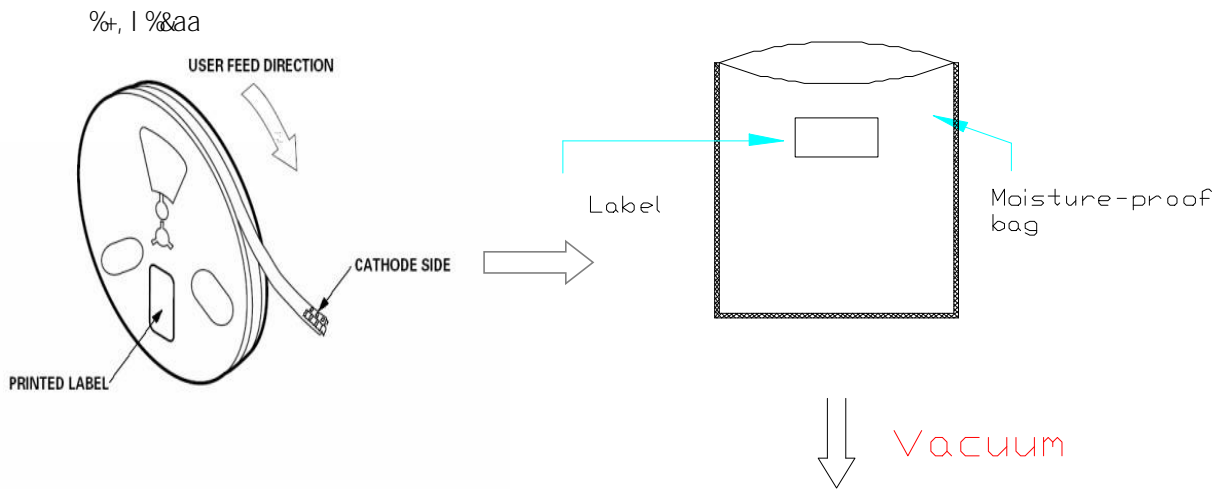
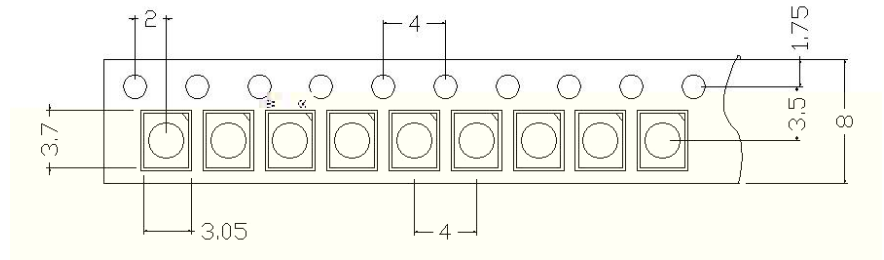

%" DUW_U[] b[GdYV\ Z] W\h] cbg

: YXX] b[8] fYVh] cb



LIGHT	
Light Electronics CO., LTD.	
MODEL NAME: _____	 LOT NO.: _____
QUANTITY: _____	
BIN: _____	
PACKING DATE: _____	
CUSTOMER P/N: _____	

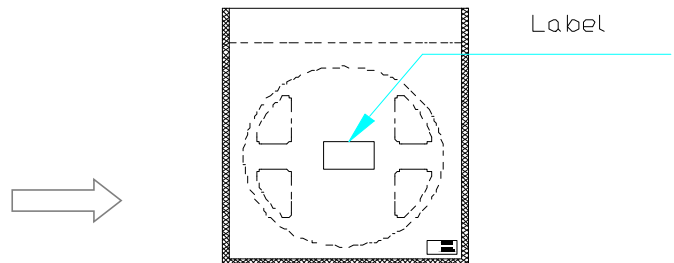

BchY. jc`iaY]g &\$\$\$dVg/

&\$\$\$dVg

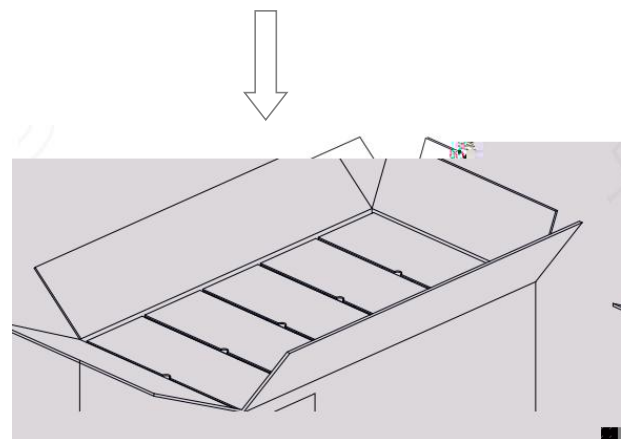

% " FY`]U]`]hm

H9GH =H9AG 5B8 F9GI @HG

	HYgh =hYa	FYZ" GhUbXUfX	HYgh 7cbX] h] cbg	BchY	7cbWi g] cb
%	FYZ` ck Gc` XYf] b[>9G8&&! 6%\$*	Hg` X1&(\$ ž%\$gYW	' h] aYg	\$#&&
&	HYadYfUhi fY 7mWY	>9G8&&! 5%\$(! &\$ ' \$a] b %&\$ ' \$a] b	&\$ \$ WmWY	\$#&&
,	HYfaU` G\cW_	>9G8&&! 5%\$*	! (\$ %&a] b %&) %&a] b	&\$ \$ WmWY	\$#&&
(<] [\ HYadYfUhi fY GhcfU[Y	>9G8&&! 5%\$'	H,1%\$\$	%\$\$\$ \fg	\$#&&
)	@ck HYadYfUhi fY GhcfU[Y	>9G8&&! 5%%	H,1! (\$	%\$\$\$ \fg	\$#&&
*	DckYf hYadYfUhi fY 7mW] b[>9G8&&! 5%\$)	Cb) a] b! (\$ 2%&a] b 0%&a] b CZZ) a] b%\$\$ 2%&a] b	&\$ \$ WmWY	\$#&&
+	@]ZY HYgh	>9G8&&! 5%\$,	H,1&) = 1%&a5	%\$\$\$ \fg	\$#&&
,	<] [\ <i a] X] hm <YUh @]ZY HYgh	>9G8&&! 5%\$%	*\$ F<1- \$i = 1%&a5	%\$\$\$ \fg	\$#&&

%" FYZ`ck dfcZ]`Y

GAB FYZ`ck Gc`XYf]b[=bghfi W] cbg

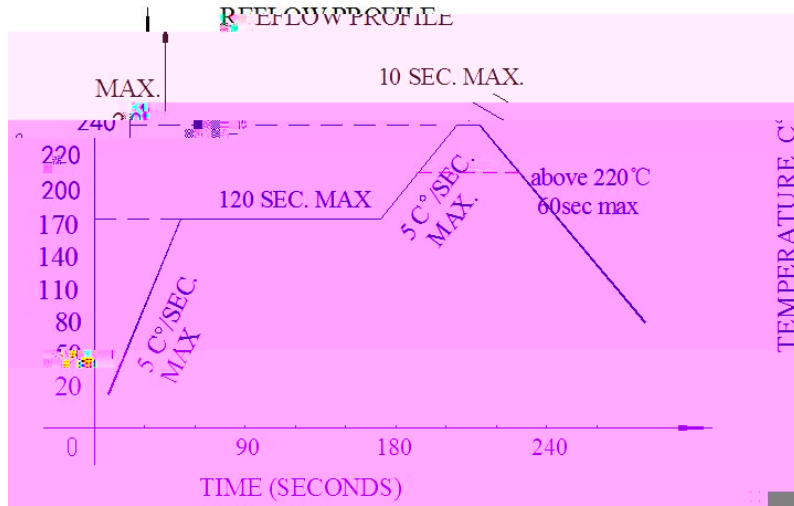

U" FYZ`ck gc`XYf]b[g\ci`X bch VY XcbY acfY h\Ub hkc h]aYg

&

V" K\Yb gc`XYf]b[žXc bch di h ghfYgg cb h\Y @98g Xi f]b[\YUh]b[

@98

Gc`XYf]b[]fcb

U" K\Yb \UbX gc`XYf]b[ž _YYd h\Y hYadYfUhi fY cZ h\Y]fcb i bXYf '\$\$ ž UbX Uh h\Uh

hYadYfUhi fY _YYd h\Y h]aY i bXYf ' gYW

' \$\$

V" H\Y \UbX gc`XYf]b[g\ci`X VY XcbY cb`m U h]aY

FYkcf_

U" 7i ghcaYf ai gh Z]b]g\ fYkcf_ k]h\]b) gYWi bXYf &(\$

&(\$)

V" H\Y \YUX cZ]fcb WUb bch hci WX h\Y @98g

@98

W Hk]b!\YUX hmdY]g dfZYffYX"

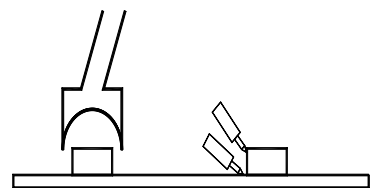

&\$" 75I H=CBG

BchY Zcf i gY

=b cfXYf hc Ybgi fY h\Uh =7 `Uad VYUXg UfY i gYX]b GAH dUhVX fYZ` ck kY` X]b[UbX]b h\Y i gY cZ h\Y dfcWgg n]Y` X UbX ghUV`] hmcZ h\Y dfcXi Vhž h\Y Zc` `ck]b[dfcWXi fYg UfY gdYW]Z]YX UZhYf aUbm hYghg.

=7 GAH

U Glad` Y Yj U i Uh]cb. 6YWUi gY h\]g dfcXi Vh]g UVi]` h!]b =7 dfcXi Vhž h\Y cj YfU` `dfcWgg]g X]ZZYfYbh Zfca Vcbj Ybh]cbU` F; 6 dfcXi Vhž gc h\Y WghcaYf g]XY bYYXg hc Wffm ci h U`! fci bX j Yf]Z]WWh]cb Xi f]b[h\Y gUad` Y Yj U i Uh]cb hc Ybgi fY h\Y aUhVX]b[dYfZcfaUbW cZ h\Y dfcXi Vh

=7 F; 6

V =bVta]b[aUhYf]U`]bgdYWh]cb. Ybgi fY h\Y j UW i a dUW]b[]g]bhUVh UbX h\YfY]g bc j UW i a `YU_U[Y" =Z h\YfY]g j UW i a `YU_U[Yž d` YUgY VcbZ]fa k\Yh\Yf h\Y fYZ` ck kY` X]b[]g UVbcfaU" =Z]h]g UVbcfaU ž d` YUgY fYhi fb hc h\Y ZUVhcfm Zcf \] [\! hYadYfUhi fY XY\i a]X]Z]WWh]cb"

W I gY. D` YUgY VcbZ]fa h\YUgY Vh I Y

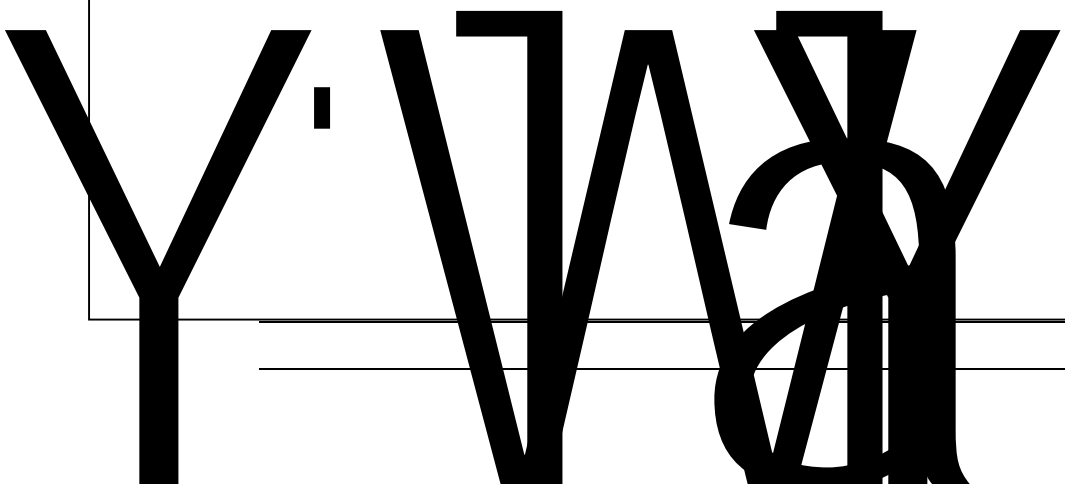

LIGHT

LIGHT ELECTRONICS CO., LTD.

