

# **SL-T3020IRC050-L236-C-S**

\_\_\_\_\_  
\_\_\_\_\_  
\_\_\_\_\_





### Electrical Optical Characteristics at Ta=25

						μ
		□				μ
			□			μ □
	2		□			
			□			
						μ
Peak Wavelength	p	---	940	---	nm	I μ □
		---	50	---	nm	I μ □
				□ □		μ
			□			μ □
				□		μ □

Note:

2

□

## Typical Electrical / Optical Characteristics Curves (25 Ambient Temperature Unless Otherwise Noted)

Fig.1 Spectral Distribution

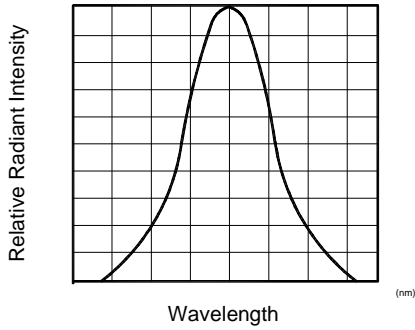

Fig.2 Forward Current Vs Ambient Temperature

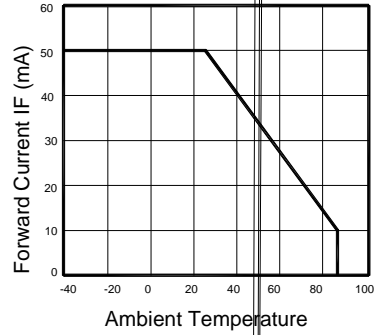

Fig.4 Relative Radiant Intensity Vs Ambient Temperature

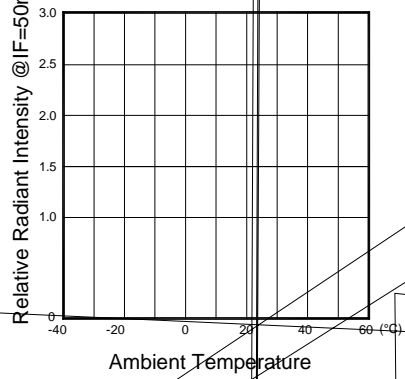
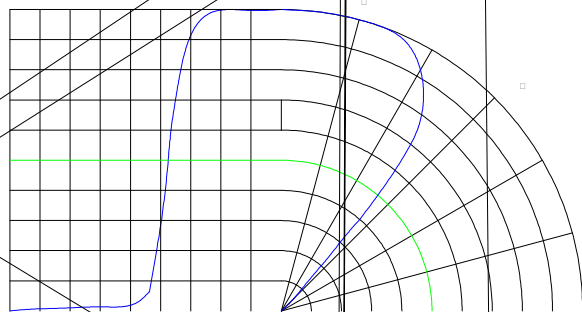

Fig.6 Radiation Diagram



0





**LIGHT**  
Light Electronics CO., LTD.

MODEL NAME: \_\_\_\_\_

QUANTITY: \_\_\_\_\_

BIN: \_\_\_\_\_

PACKING DATE: \_\_\_\_\_

REMARKS: \_\_\_\_\_

LOT NO. :  

**LIGHT**  
Light Electronics CO., LTD.

MODEL NAME: \_\_\_\_\_

QUANTITY: \_\_\_\_\_

BIN: \_\_\_\_\_

PACKING DATE: \_\_\_\_\_

CUSTOMER P/N: \_\_\_\_\_

LOT NO. :  

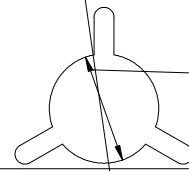
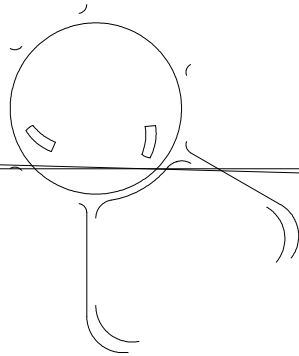

φ132±0.03

- B1



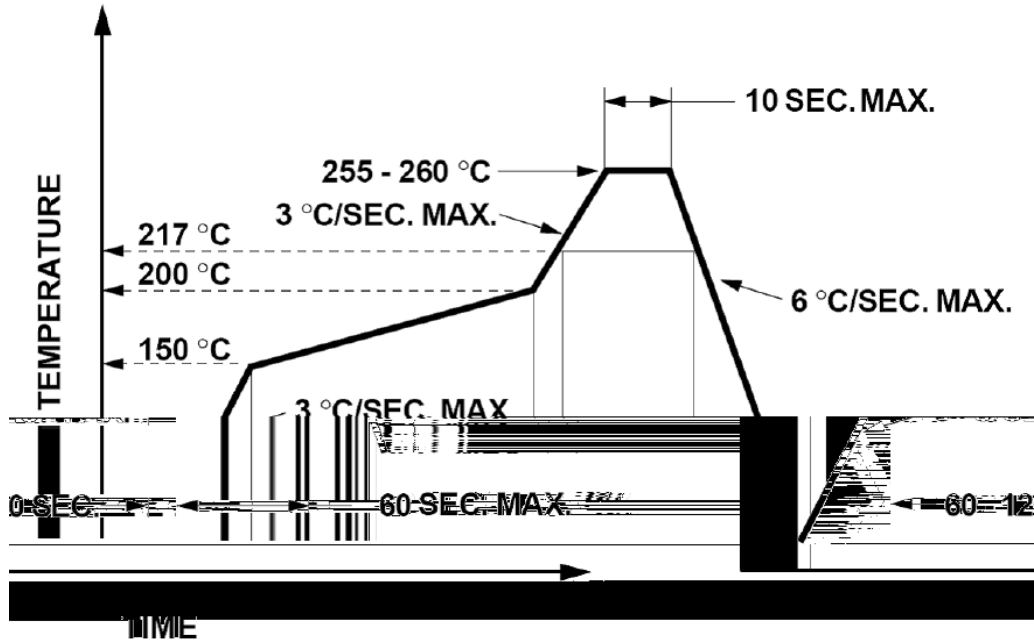

°C

